

Contents

1. Introduction and Installation	1
GstarCAD8 Introduction	1
System Requirements	1
GstarCAD8 Installation	2
2. Starting up GstarCAD8	4
The User Interface	4
Quick Access Toolbar	4
Workspace Switching	4
Menu Bar	5
Menus and Shortcut Menus	5
Shortcuts Customize	5
The Ribbon	6
Appearance	7
Drawing Area	7
Toolbars	7
Displaying and Hiding Toolbars	8
Starting Commands Using Toolbars	8
User Coordinate System (UCS)	9
Model Space and Layout Space tabs	9
Command Window	9
Enter Commands on the Command Line	10
Specify Command Options	10
Execute, Repeat and Cancel Commands	10
Nesting a Command	10
Enter System Variables on the Command Line	11
Using the Prompt History Window	11
Switch Dialog Boxes and Command Line	11
Dynamic Input	11
Status Bar	12
Properties Palette	12
Customize the Drawing Environment	13
Set Interface Options:	13
Settings of Modifying Interface	13
Save and Restore Profiles	14
Tool Palettes	15
Design Center	15
3. Create, Open, Save and Recover a Drawing	16
Create a Drawing	16
Create a New Drawing Using Default Settings	16
Create a New Drawing Using a Setup Wizard	16
Create a New Drawing Using Template	17
Open a Drawing	17

Open a Drawing	17
Multiple Open Drawings.....	18
Save a Drawings.....	18
Save a Drawing	18
Save Your Drawing Automatically	19
Save Part of a Drawing File	19
Save to a Different Type of Drawing File	19
Use Backup Files	19
Reduce the Time Required to Save a Drawing File.....	20
Recover a Drawing	20
Recover a Damaged File	20
Drawing Recovery Manager.....	21
4. Control the Drawing Views	22
Redraw and Regenerate a Drawing	22
Magnify a View (Zoom)	22
Zooming Methods.....	23
Zoom to Magnify a Specified Rectangular Area	23
Zoom in Real Time	23
Displaying the Previous View of a Drawing.....	24
Zooming to a Specific Scale	24
Displaying the Entire Drawing	24
Pan and View.....	25
Display Multiple Views on Model Space	25
Set Model Space Viewports	25
Working with Multiple Views of a Single Drawing	26
Working with Multiple Drawings.....	27
View Manager	27
Specify a 3D View	27
Set the Viewing Direction	27
Isometric View	29
Draw 2D Isometric Views	29
Set Isometric Grid and Snap	30
Change a 3D View Dynamically	31
Hide Lines or Shade 3D Objects	31
Add Simple Shading to 3D Objects.....	32
Render	32
Render Environment.....	32
Light	33
Materials.....	33
5. Precision Tools and the properties of Drawing.....	33
Specify Units, Angles and Scale	33
Set the Units Format	33
Set Angle Conventions.....	34
Setting Scale Factors	34

Drawing Limits	35
Grid and Grid Snap	35
Change Grid and Snap Spacing	35
Use Object Snaps	36
Setting Object Snaps	36
AutoSnap Tool.....	36
Use Polar Tracking and Object Snap Tracking	37
Polar Tracking	37
Object Snap Tracking	38
Use Orthogonal (Ortho Mode).....	38
Working with Linetypes	39
Load Linetypes.....	39
Change the Linetype of an Object	39
Set the Current Linetype.....	40
Control Linetype Scale.....	40
Working with Layers	41
Create and Name Layers	41
Setting the Current Layer.....	41
Removing Layers.....	41
Controlling Layer Visibility	42
Locking and Unlocking Layers.....	42
Controlling Layer Printing	42
Setting a Layer's Print Style.....	43
Freeze or Thaw Layers	43
Setting the Layer Color.....	43
Setting a Layer's Linetype.....	44
Setting a Layer's Lineweight.....	44
Filter List of Layers.....	44
Displaying Lineweights	45
Display Lineweights in Model Space	45
Display Lineweights in Layouts	45
6. Create Objects.....	46
Draw Linear Objects.....	46
Lines.....	46
Multilines.....	46
Ray	47
Construction Lines	47
Polylines	49
Polygons.....	49
Rectangles	50
Points.....	50
Freehand Sketches.....	51
Draw Curved Objects.....	51
Arcs	51

Circles	52
Ellipses	52
Splines	53
Helix	54
Donut.....	54
Create 3D Objects	55
3D Thickness and Elevation	55
3D Faces.....	55
Ruled Surfaces.....	56
Tabulated Surface.....	56
Revolved Surface	56
Solid Box	57
Solid Cone.....	57
Solid Cylinder	57
Sphere	58
Torus.....	58
Pyramid	58
Wedge	58
Solids Extrude.....	59
Solids Revolve	59
Creating Composite Solids	59
Create Regions	60
Create Revision Cloud	60
Create Break Line	60
Create Wipeout	60
7. Modify Objects.....	61
Remove Objects	61
Copy Objects	61
Mirror Objects.....	61
Offset an Object	62
Create an Array of Objects.....	62
Move Objects.....	63
Rotate Objects.....	63
Align Objects	63
Scale Objects.....	64
Lengthen Objects	64
Stretch Objects	64
Trim Objects.....	65
Extend Objects.....	65
Create Breaks	66
Create Chamfers.....	66
Create Fillets	67
Trim and Extend Filleted Objects.....	68
Fillet Line and Polyline Combinations	68

Fillet Parallel Lines.....	68
Disassociate Compound Objects	68
Modify Polylines	69
Modify Multilines.....	69
8. Notes and Labels.....	70
Create Text	70
Single-Line Text	70
Multiline Text	70
Work with Text Styles.....	72
Create Leader	72
Leaders	72
Modify Text	73
Change Text	73
9. Dimensions and Tolerances.....	74
Create Dimensions	74
Horizontal and Vertical Dimensions	74
Create Aligned Dimensions.....	74
Create Baseline and Continued Dimensions.....	75
Create Rotated Dimensions	75
Create Angular Dimensions.....	75
Create Radial Dimensions	76
Jogged Dimension.....	76
Create Diameter Dimensions	76
Create Ordinate Dimensions	76
Create Quick Dimension.....	77
Create Arc Length Dimension	77
Use Dimension Styles	77
Dimension Styles.....	72
Modify Dimension Lines	79
Modify Extension Lines	79
Choose Dimension Arrowheads	79
Fit Dimension Text within Extension Lines.....	79
Fit Diameter Dimension Text	80
Align Dimension Text	80
Position Dimension Text Vertically.....	80
Position Dimension Text Horizontally	80
Dimension Units	81
Alternate Units	81
Display Lateral Tolerances.....	81
Set the Scale for Dimensions	82
Modify Existing Dimensions.....	83
Modify Dimension Style.....	83
Make Dimensions Oblique	83
Dimension Jogged Linear	83

Dimension Inspection	84
Adjust Dimension Space.....	84
Add Geometric Tolerances	85
Geometric Tolerance Dialog Box	85
Geometric Tolerance Symbols	85
Material Conditions.....	86
Datum Reference Frames	86
Projected Tolerance Zones	86
Composite Tolerances.....	86
10. Blocks, Attribute and Xrefs	87
Create and Insert Blocks.....	87
Create Blocks.....	87
Create Nested Blocks	87
Create Drawing Files for Use as Blocks	88
Change the Base Point of Drawings to Be Used as Blocks.....	88
Update Changes in the Original Drawing.....	88
Use Paper Space Objects in Blocks	88
Insert Blocks	88
Modify a Block Definition.....	89
Remove Block Definitions	89
Define and Use Block Attributes	90
Extract Block Attribute Data	91
Reference Other Drawing Files (Xrefs)	91
Attach External References	91
Control the Properties of Referenced Layers	92
Xref Clipping Boundaries	92
Nest and Overlay External References	92
Binding an Xref to a Drawing.....	92
Refresh Xrefs.....	92
11. Hatches and Raster Images	93
Hatches	93
Define Hatch Boundary	93
Control the Hatching in Islands	94
Choose and Define Hatch Patterns	94
Solid	95
Work with Raster Images	96
Attach, Scale, and Detach Raster Images	96
Attach Raster Images	96
Scale Raster Images	96
Detach Raster Images	96
Modify and Manage Raster Images	96
Change Raster Image Brightness, Contrast, and Fade	97
Improve the Display Speed of Raster Images	97
12. Layout, Plot and Publish Drawing	98

Create Multiple-View Drawing Layouts	98
Overview of Layout	98
Work with Model Space and Paper Space	98
Specify Layout Settings	99
Select a Paper Size for a Layout	99
Determine the Drawing Orientation of a Layout.....	99
Adjust the Plot Offset of a Layout	99
Set the Plot Area of a Layout	100
Set the Plot and Lineweight Scale for a Layout	100
Move and Copy Layouts	100
Create Layout from Template	100
Create and Modify Layout Viewports	101
Plot Drawings.....	102
Plot Settings	102
Set Paper Size.....	102
Position the Drawing on the Paper.....	102
Set Drawing Orientation	103
Set Plot Scale	103
Set Plot Options.....	103
Specify the Area to Plot.....	104
Preview a Plot	104
Use Plot Styles	104
Plot Files to Other Formats	105
Publish Drawings	106
13. Create and Edit Dynamic Blocks	107
Dynamic Block Editor	107
Dynamic Block Editor Tool Panels	107
Parameters.....	108
Actions	110
Dynamic Blocks Creation Samples.....	111
Base Point Parameter	111
Visibility.....	111
Alignment	113
Point Movement.....	114
Linear Movement	115
Number of Grips	115
Angle Offset	116
Linear Stretch.....	116
Parameter Value Set.....	116
Symmetrical Stretch	117
Distance Multiplier.....	117
Chain Action	118
Scale Action	119
Scale Character.....	120

Rotation	122
Polar Stretch	122
Polar Stretch Action Characteristics	124
Array	125



GstarCAD8 Introduction

GstarCAD8 is a brand new platform thought to satisfy user's needs. GstarCAD8 adopts a new engine more agile and compatible with a number of innovative technologies that work bonded to make its graphic speed 3-5 times faster, accelerating operation performance and reaching less memory usage than previous versions. Not only the speed and performance are guaranteed but also the stability concept has changed radically through a new modular architecture software. These three links empower GstarCAD8 to boost speed and performance beyond complex tasks on huge drawings supported by outstanding stability than any other CAD platform.

This section helps you get started using GstarCAD8 software by explaining how to install it and providing basic information about how to use it.

System Requirements

Before installing GstarCAD, please confirm whether the specifications of your PC meet the following requirements:

OS (Operating System)		Windows XP Home and Professional Edition SP2 or later Microsoft Windows Vista SP1 or later Windows 7 (32 bit, 64 bit) Windows 8 (32 bit, 64 bit)
CPU		Windows XP - Intel Pentium 4 or AMD Windows Vista - Intel Pentium 4 or AMD Athlon™ Dual Core processor, 1.6 GHz or higher with SSE2 technology Athlon™ Dual Core processor, 3.0 GHz or higher with SSE2 technology
RAM		Windows XP - 512 MB RAM Windows Vista - 1 GB RAM Windows 7 - 1 GB RAM Windows 8 - 1 GB RAM
DISPLAY		1024 x 768 VGA with True Color (minimum)
HARD DISK		512MB or higher

GstarCAD8 Installation

Users can visit www.gstarcad.net to download GstarCAD8 to your computer or server.

GstarCAD8 installshield wizard will guide the user to complete successfully the installation of the software in the operating system. GstarCAD8 standard and professional versions are not the same. The software will automatically distinguish according to the user when registering dongle or serial number. The installation steps are as follow:

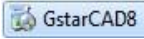
1.- Double-click the executable file downloaded  and the "Gstarcad-InstallShield Wizard" dialog box will pop up. Click the "Next" button to continue the installation. See figure 1-1.

2.- The "License Agreement" dialog box is displayed. If you agree, check "I accept the terms of license agreement" and click the "Next" button to continue the installation. See figure 1-2.



Figure 1-1

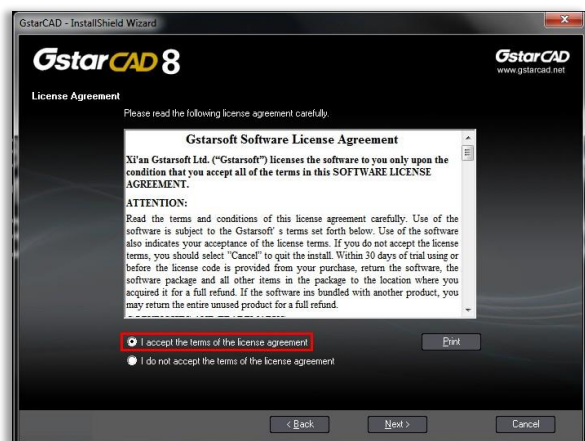

Figure 1-2

3.- The "User Information" dialog box pops up, enter your user information and click the "Next" button. See figure 1-3.

4.- Then choose the destination path where setup will install the files and click the "Next" button as shown in Figure 1-4.



Figure 1-3



Figure 1-4

5.- Then "The install option" dialog box pops up, you can choose between uncheck or check the VBA option. To continue with the installation just click the "Next" button. See figure 1-5.

6.- Then the wizard is ready to begin the program installation. If you want to review or change any of your installation settings just click the "Back" button. Click the "Install" button to continue with the installation. See figure 1-6.

7.- Then "The GstarCAD wizard" dialog box pops up. The GstarCAD wizard has successfully installed the program. Click the "Finish" button to exit the wizard. See figure 1-7.



Figure 1-5



Figure 1-6

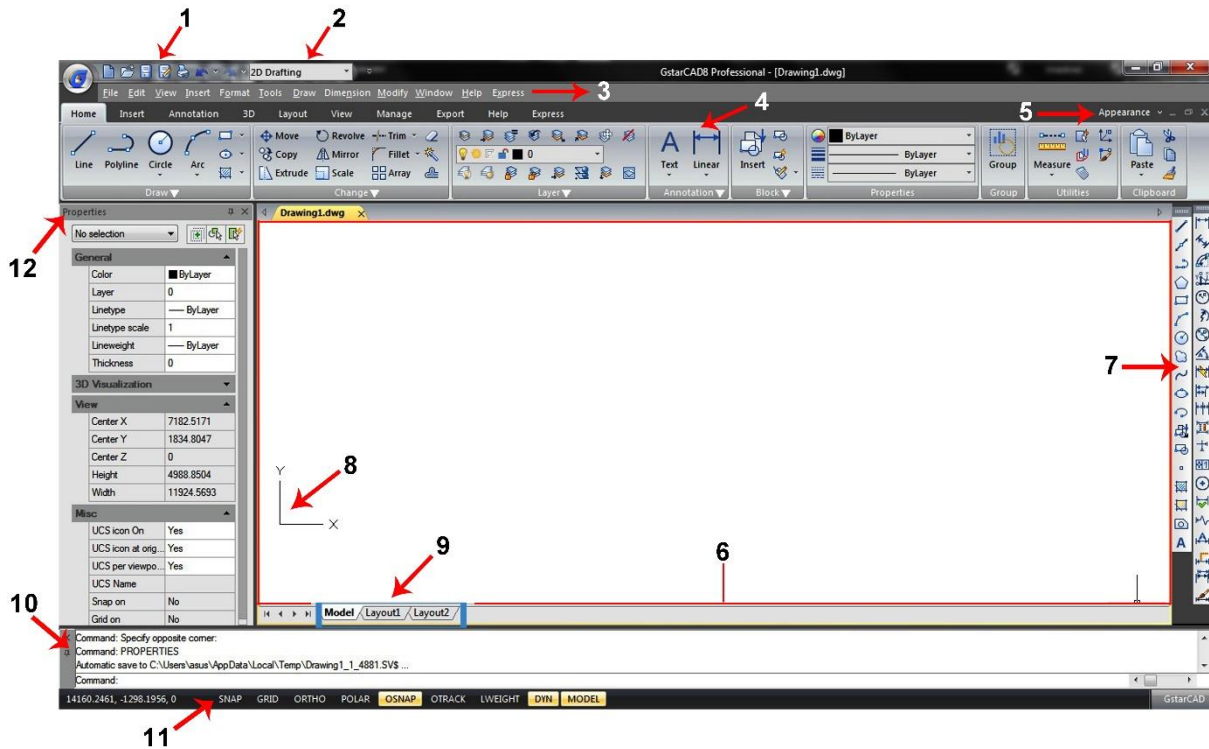

Figure 1-7

Starting up GstarCAD8

The User Interface

You can enjoy working at GstarCAD8 environment in different ways. You can display and rearrange elements like the toolbars, display the command bar, switch between workspaces, change the interface themes and enable the status bar. The toolbars and command bar can also be floated anywhere on the screen or docked as well.



1.- Quick Access Toolbar:

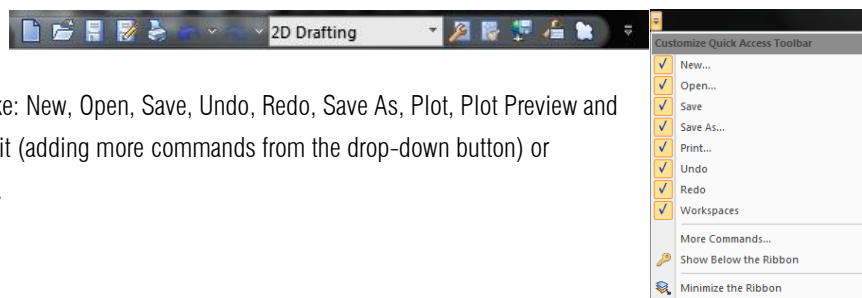

Display the frequently used tools like: New, Open, Save, Undo, Redo, Save As, Plot, Plot Preview and Help. Moreover you can customize it (adding more commands from the drop-down button) or showing it below/above the ribbon.

2.- Workspace Switching: Switch between two workspaces (2D Drafting and GstarCAD Classic).

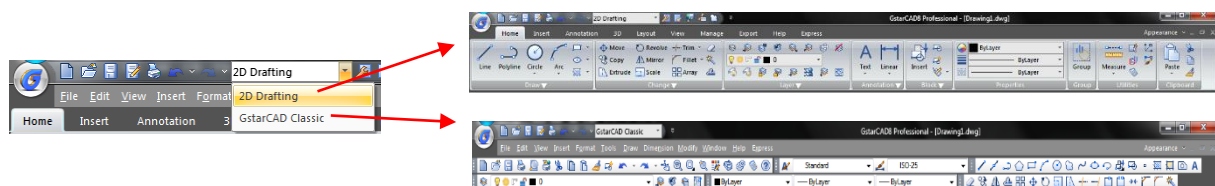

3.- Menu Bar: The menu bar is used for selecting commands by mouse instead of inputting commands by keyboard. In it you can find the follow menu tabs: File, Edit, View, Insert, Format, Tools, Draw, Dimension, Modify, Window, Help and Express.

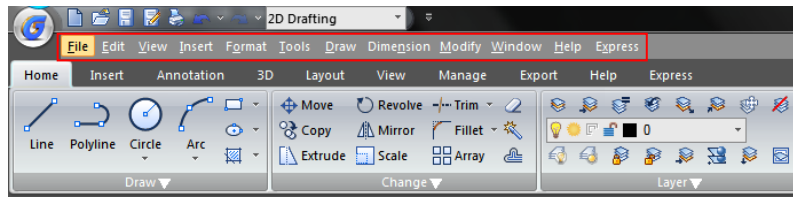

Menus and Shortcut Menus

You can use any of the option on the Menus from the menu bar at the top of the drawing area. Choose one of the following methods to use a menu:

- On the menu bar, click a menu name to choose the menu or to expand a list of options.
- Press Alt and the key for the underlined letter in the menu name to open the corresponding menu item list, and then choose menu items from it. For example, to edit the drawing file, press <Alt+E> to open the Edit menu.

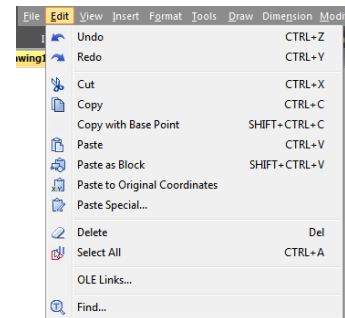

Shortcut menus provide quick access to specific commands. A shortcut menu displays when you right click an object, status bar, the Model tab name, or a Layout tab name. The selections presented in the shortcut menu depend on what you clicked.

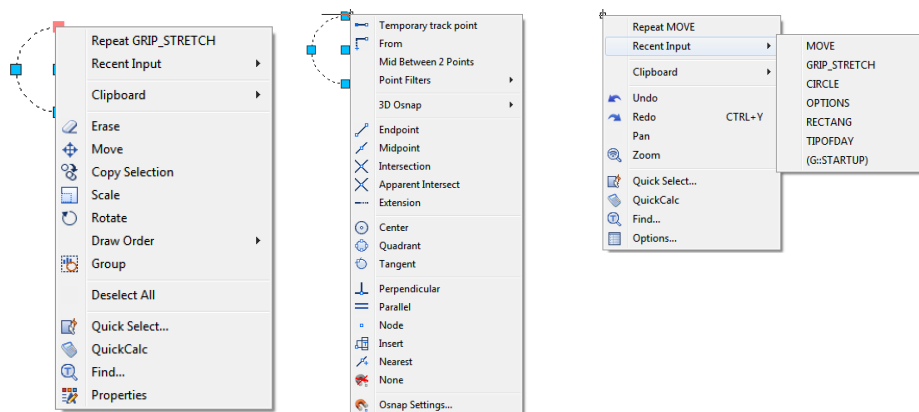

Shortcuts Customize

A faster way to invoke a command is customize its shortcut. The CUSTACC command allows you to customize, delete or modify existing command shortcuts. To access this command go through the menu bar, under tools, select customize and choose Shortcuts Customize. After that, the shortcut customize window will pop up. As you can see, there is a list of shortcuts command that you can easily modify, delete or even make a new one over an existing one.

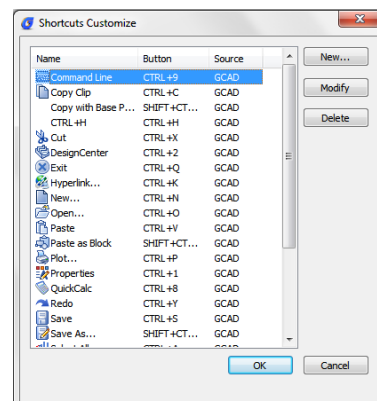

If you want to create a new one, just click the New button and the customize command window will pop up. Then you can search the command or select one from the command list. For example, you can input "command line" and then select the requested command. Notice that by selecting the requested command, at the right side of the window, will display the command properties. After selecting the command, press the OK button.

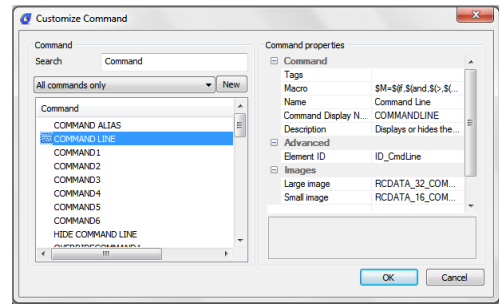

Then the set shortcut window will pop up. You can input the desire keyword(s). For example, you can input the number 1. If you want to delete a created shortcut command, invoke the command CUSTACC and then select the delete button from the Shortcut Customize window.

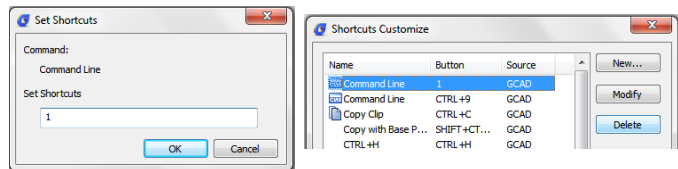

4.- The Ribbon: The ribbon consists of several panels, which are organized into each tab according to their task label. The tools and controls in each panel are also available in toolbars and dialog boxes.

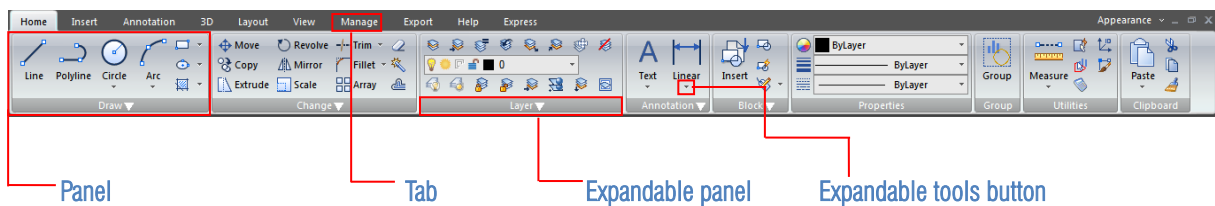

Tab: The ribbon is structure by tabs. Every tab displays a series of panels with its own tools (commands or thumbnails) easier to select or pick.

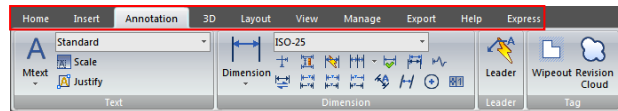

Panel: The panel shows the most used tools. Some thumbnails has an expandable tools button that can be expanded in a drop-down method. In addition, most of panels at home tab have an expandable panel that show up more commands related.

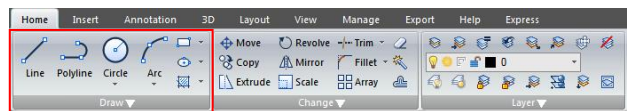

Expandable Panel: The expandable panel is located at the bottom of the panel. If you click at the bottom of the panel, more commands related will be displayed.

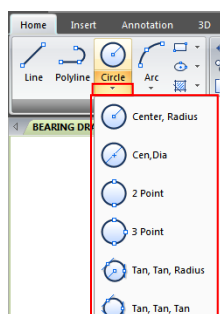
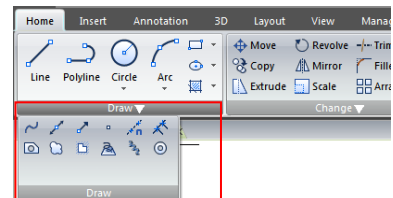

Expandable Tools Button: Some thumbnails (tools or commands at the panel) have an expandable tools button that can be expanded in a drop-down method. If you click this button, all related tools will be displayed.

5.- Appearance: You can manage the interface's theme plus show/display toolbars, menu bar, file tabs and status bar.

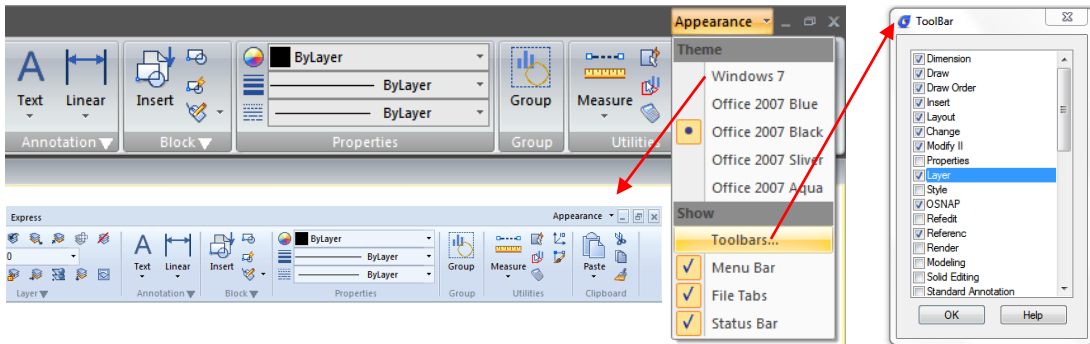

6.- Drawing Area: Your drawings are displayed in the drawing window.

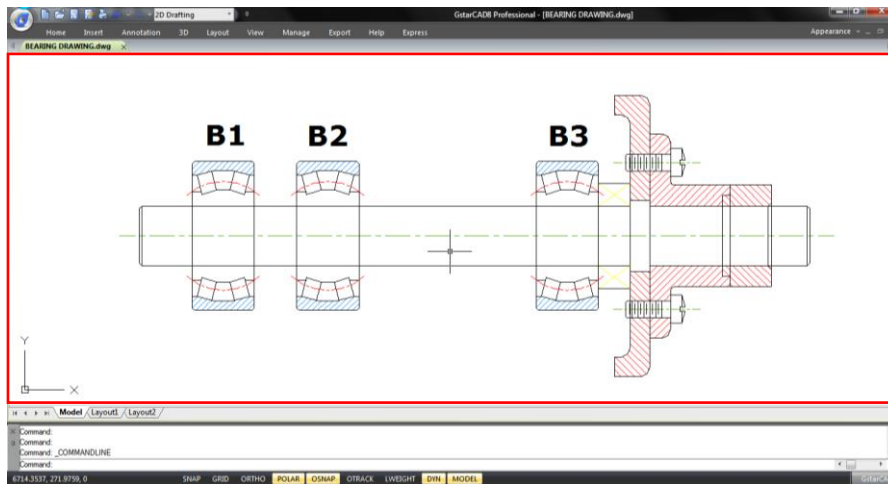

7.- Toolbars: Toolbars partially contain buttons that start commands. When you move your mouse or pointing device over a toolbar button, the tooltip displays the name of the button.

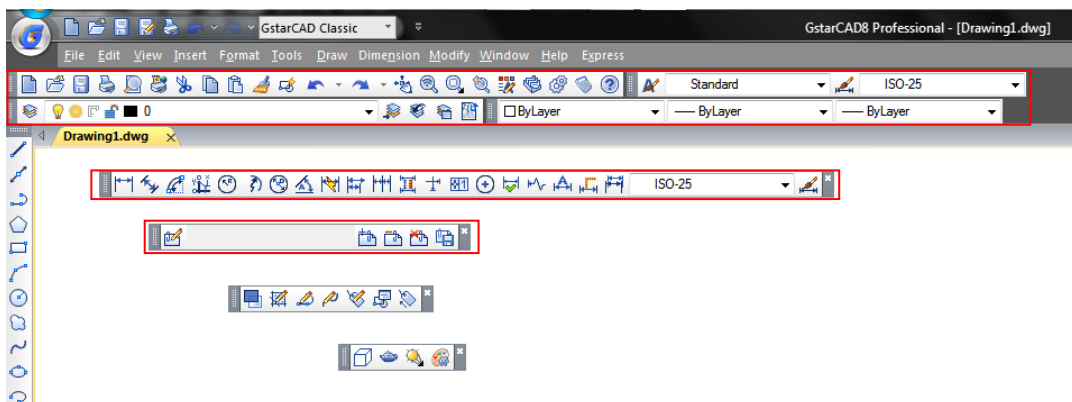

The Standard toolbar at the top of the drawing area contains commonly used commands such as Copy Pan and Zoom, as well as Microsoft Office standard commands such as New, Open, and Save. GstarCAD8 classic workspace initially displays several toolbars by default:

- Draw toolbar
- Draw order toolbar
- Change toolbar
- Properties toolbar
- Layer toolbar
- Style toolbar
- Standard toolbar

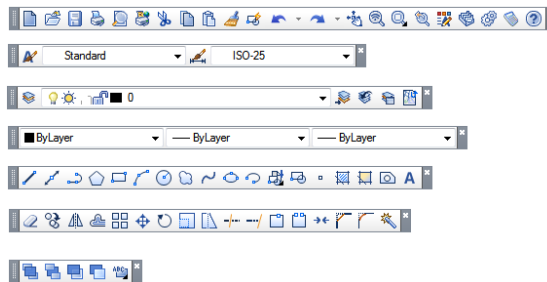

Displaying and Hiding Toolbars

GstarCAD8 provides many toolbars, which you can show or hide in both classic and ribbon interfaces. You can also move and dock toolbars. To choose which toolbars to display:

- 1.- Execute TOOLBAR command or select the option TOOLBARS from the drop-down list under Appearance button (at top right of the interface) to open the Toolbar dialog box.
- 2.- Choose the toolbars you want to hide or display by checking/unchecking the small boxes in the dialog box, then click OK.

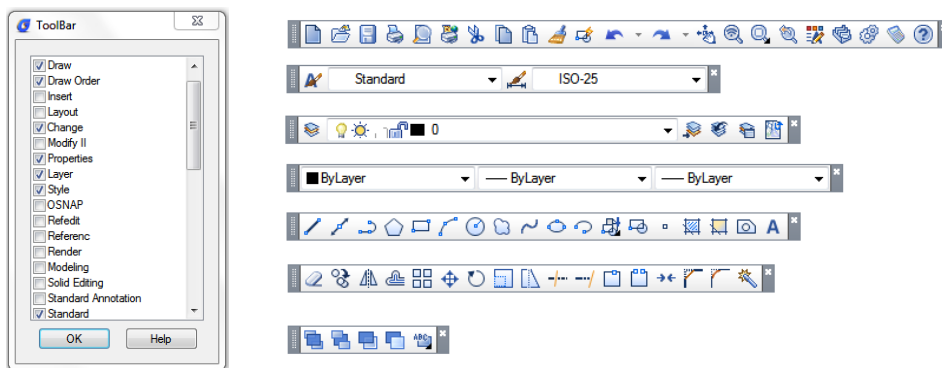

To make floated a horizontal docked toolbar, just click and hold the left side of it and drag around the place you need.

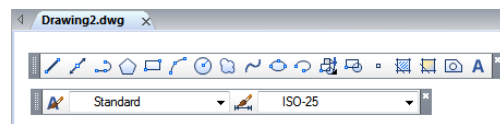

To make floated a vertical docked toolbar, just click and hold the top of it and drag around. To dock any toolbar, just double-click at the left side of it.

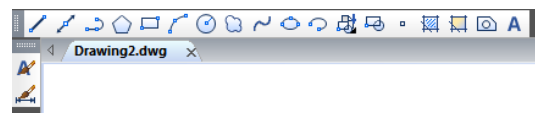

Starting Commands Using Toolbars

To start a command from a toolbar, click a command button and respond to the prompts.

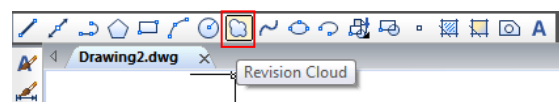

8.- User Coordinate System (UCS): The icon indicates the orientation of the drawing in two dimensional space.

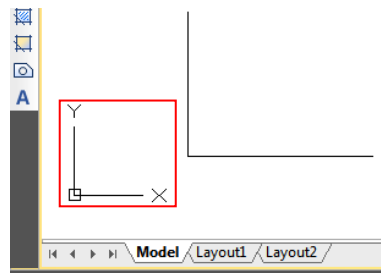

9.- Model Space and Layout Space tabs: Click a tab to switch between the drawing of your model and a printed layout.

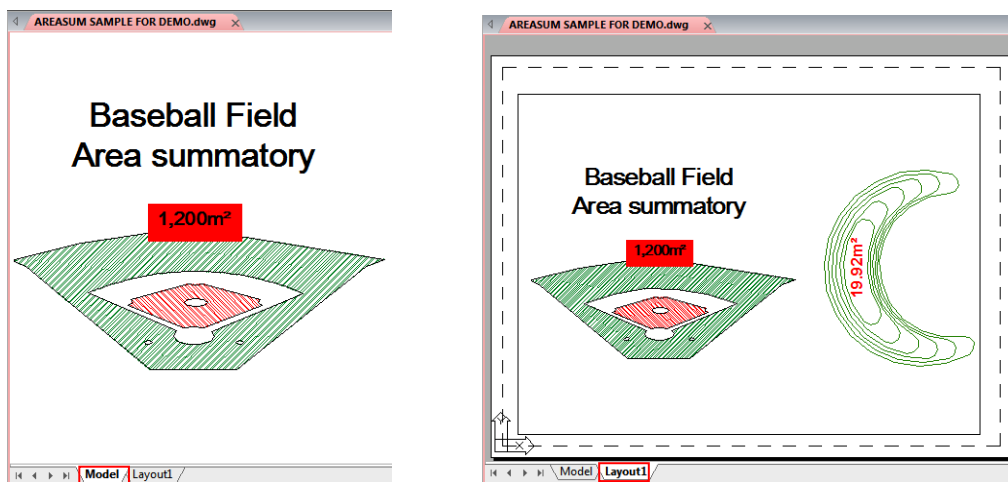

10.- Command Window: The command bar is a dockable window in which you can type commands and view prompts and other program messages. You can move the command bar by dragging it.

When the command bar is floating, you can drag the top or bottom of the window to change the number of lines of text it displays. You can dock the command bar at the top or bottom of the drawing.

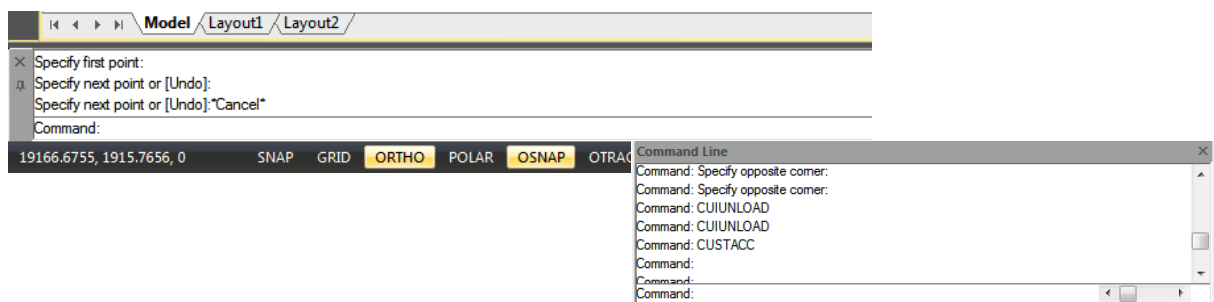

Enter Commands on the Command Line

Type the full command on the command line and press ENTER or SPACEBAR, or right-click your pointing device to start the command. Some commands also have abbreviated names (aliases).

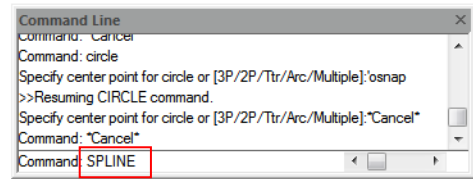

Specify Command Options

Once you have entered a command on the command line, it displays a set of options or a dialog box. To choose a different option, enter one of the options in the brackets (either uppercase or lowercase letter is OK), and then press ENTER or SPACEBAR

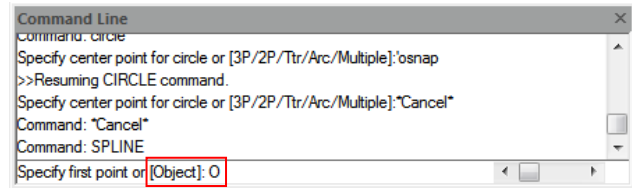

Execute, Repeat and Cancel Commands

To execute commands, press SPACEBAR or ENTER, or right-click your pointing device when the command names has been entered or responsive to prompts. If you want to repeat a command that you have just used, press ENTER or SPACEBAR. To cancel a command in progress, press ESC.

Nesting a Command

To use a command inside an active command, type an apostrophe before you type the command. For example, you turn on the object snap while you are drawing a circle, thus you can setup Object snap mode before continuing drawing.

Command: circle > *Specify center point for circle or [3P/2P/Ttr (tan tan radius)]: 'osnap*

(Setup object snap mode as Center in Draft Settings dialog, and then close the dialog to go on performing CIRCLE command)

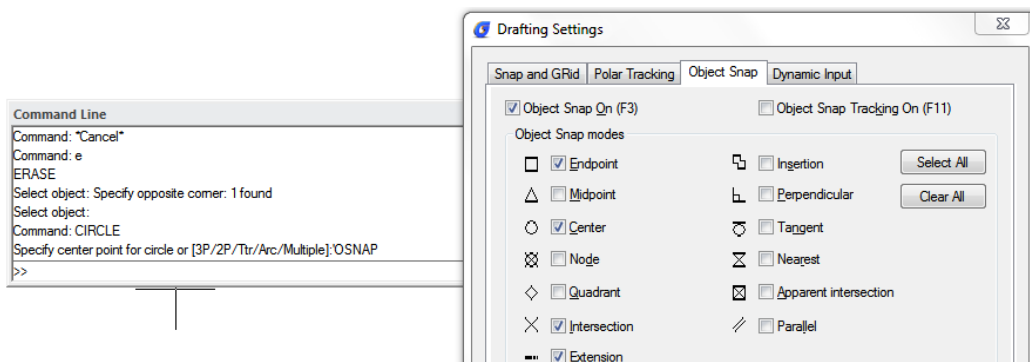

Enter System Variables on the Command Line

System variables are available for controlling how certain commands work. For example, GRIDMODE is used to control the grid status ON or OFF.

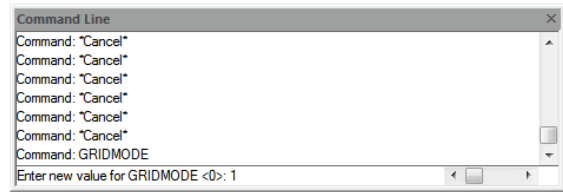

Using the Prompt History Window

The Prompt History window displays a history of the commands and prompts issued since you started the current session of GstarCAD.

To display or close the Prompt History window press F2.

To view entries in the Prompt History window, just drag the scroll bars or use the Up (↑) and Down (↓) arrows to display previously used commands.

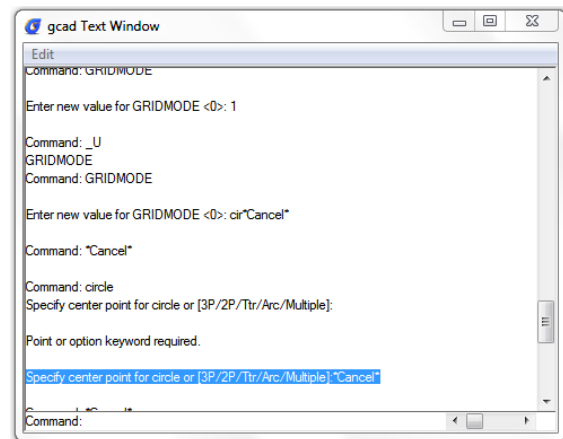

Switch Dialog Boxes and Command Line

If you enter LINETYPE on the command line, the Linetype Manager dialog box will pop up. Entering -LINETYPE on the command line displays the equivalent command line options. The system variables below affect the display of dialog boxes as well:

- ATTDIA controls whether INSERT uses a dialog box for attribute value entry.
- EXPERT controls whether certain warning dialog boxes are displayed.
- FILEDIA controls the display of dialog boxes used with commands that read and write files. For example, if FILEDIA is set to 1, OPEN displays the Open Drawing As dialog box. If FILEDIA is set to 0, OPEN displays prompts on the command line. Even when you set FILEDIA to 0, you can get a file dialog box displayed through entering a tilde (~) at the first prompt.

Dynamic Input

"Dynamic input" box is a floating window which appears near the cross cursor. It provides a convenient method for users to input commands or system variables dynamically and display the index information. When the DYN mode is turned on, a drop-down box will appear near the cross cursor.

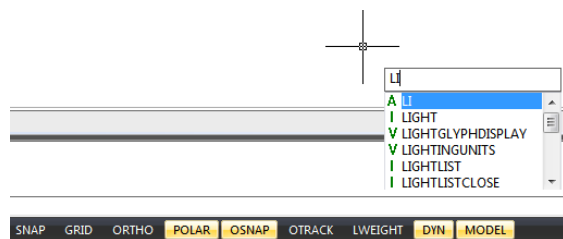

11.- Status Bar: Display information such as the current cursor coordinates, Snap, Grid, Ortho, Polar, Osnap, Otrack and other settings. In addition to displaying information, the status bar is a quick way to access many features. You can click status bar items to make changes, and right click items to display short cut menus that allow you more choices. By default, the status bar is shown as the picture below:

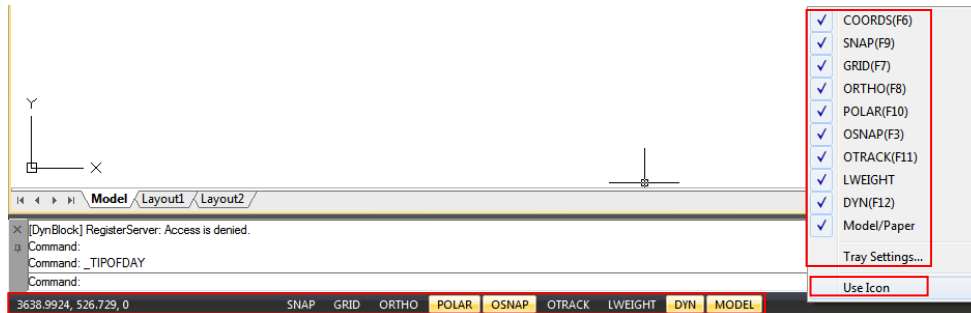

By doing right click mouse on an empty are of the status bar, you can show or hide commands or even change these into icons:



12.- Properties Palette: You can modify the value or properties of object(s) you wanted in each column. The Properties palette shows all properties of the specified object. When selecting multiple objects, the Properties palette shows the command properties of the selected objects. If none of the object is selected, the Properties palette displays the general properties of the current layer, View properties as well as the UCS information. By default, double-click an object opens Properties palette if the Properties palette is hidden. This operation is not available when the objects are block, hatch pattern, text, multiline, external reference or gradient fill.

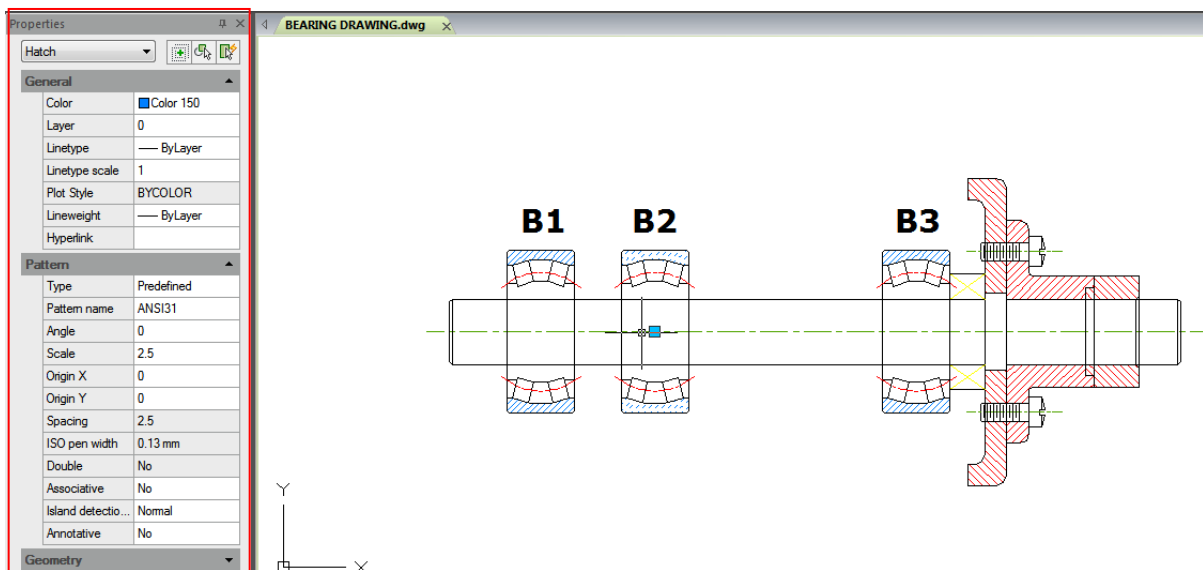

Customize the Drawing Environment

In GstarCAD8 there are different elements of the working environment that can be customized to fit your needs.

Set Interface Options

In the Options dialog box, you can change many of the settings that affect the interface and drawing environment.

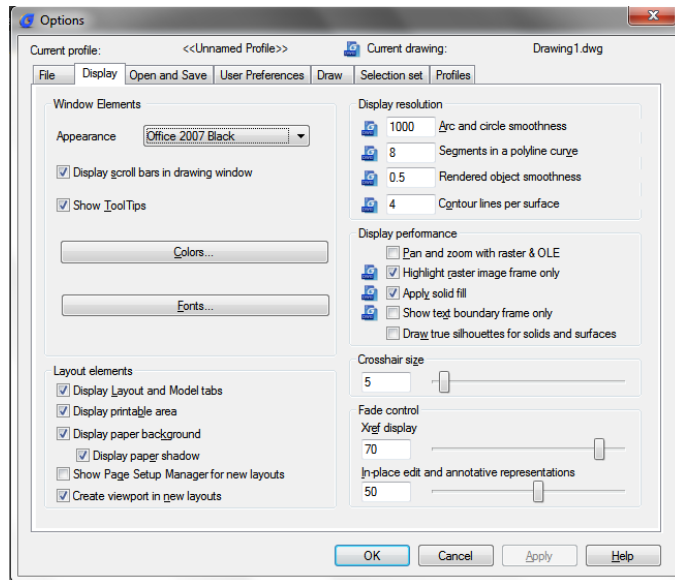

Settings of Modifying Interface:

Automatic Save (Open and Save tab): Save your drawing at specified time intervals. To use this option, in the Options dialog box, Open and Save tab, select Automatic Save and enter the interval in minutes.

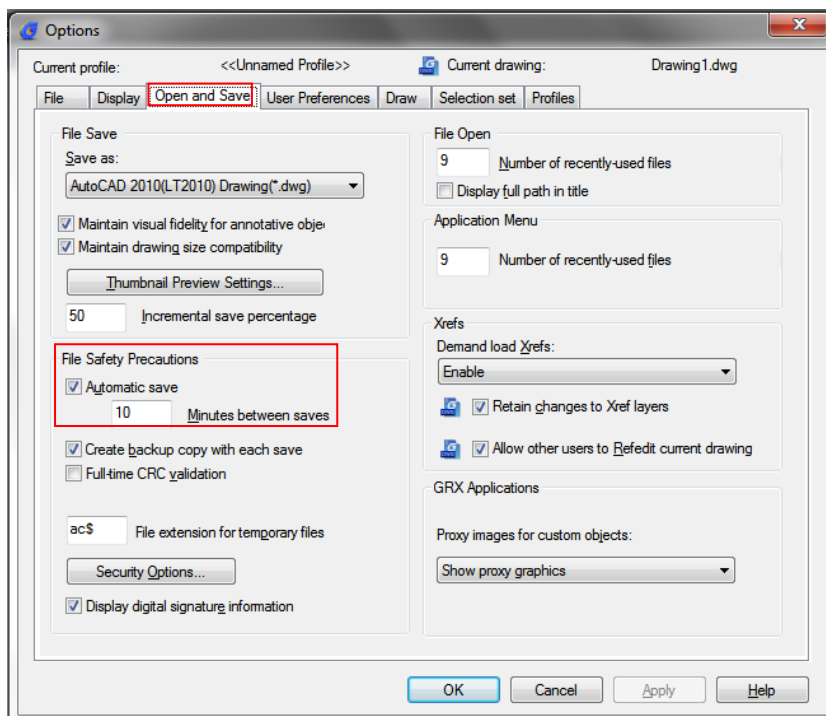

Color (Display tab): Specify the background colors used in the layout and Model tabs and the color used for prompts and crosshair.

Font (Display tab): Change the fonts used in the window and in the text window. This setting does not affect the text in your drawings.

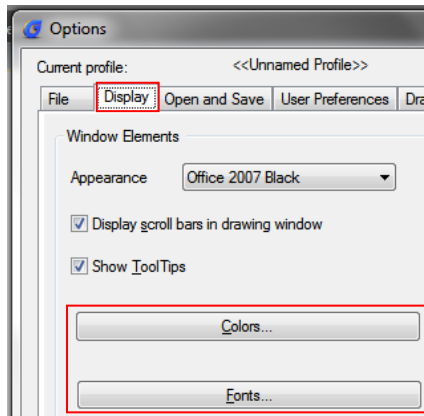

Search Path (Files tab): Set the search path to find drawing support files such as text fonts, drawings, linetypes, and hatch patterns.

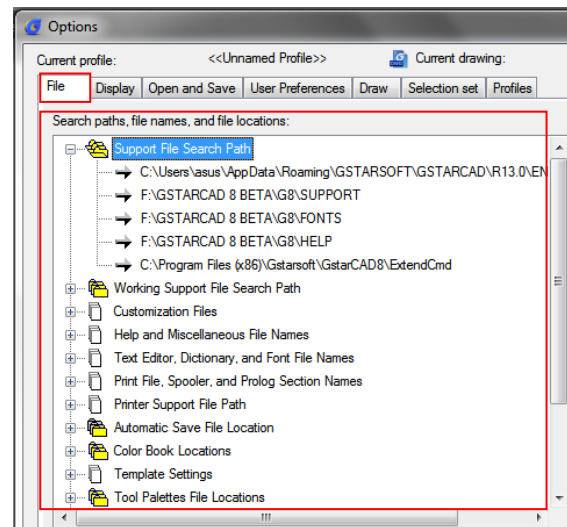

Save and Restore Profiles

Creating profiles for different users or projects and sharing profiles by importing and exporting profile files are enabled in GstarCAD8. By default, your current options are stored in a profile named Default. The current profile name, as well as the current drawing name, is displayed in the Options dialog box.

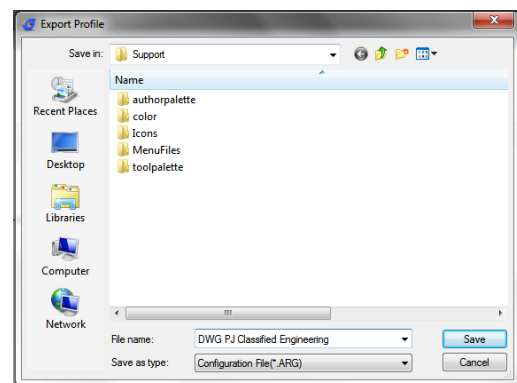
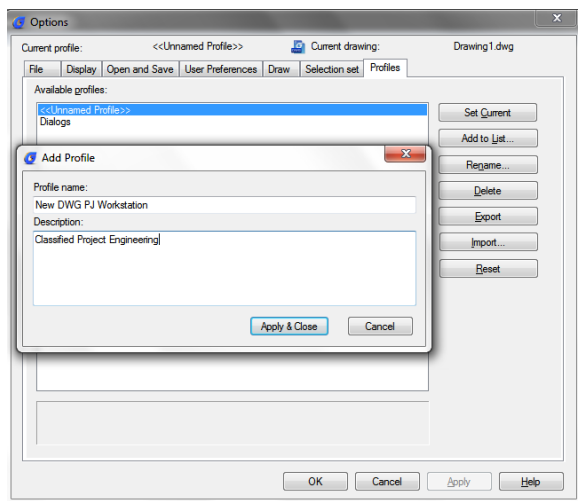

GstarCAD8 stores the profile information in the system registry and saves it as a text file (an ARG file) and also organizes essential data and maintains changes in the registry as required.

If you make changes to your current profile during a session and you want to save those changes in the ARG file, you must export the profile. When you export the profile with the current profile name, GstarCAD updates the ARG file with the new settings. You can re-import the profile into GstarCAD8 to update your profile settings.

Tool Palettes

Tool palettes are tabbed areas within the Tool Palettes window. The items you add to a tool palette are called tools. You can create a tool by dragging an object onto the tool palette. In GstarCAD, blocks and external references (xrefs) can be dragged onto the tool palette. The new tool inserted will have the same properties into your drawing. Also you can create, delete, rename and customize panels by doing right click on it. To open the tool palettes just press CTRL + 3 or Type TOOLPALETTES command.

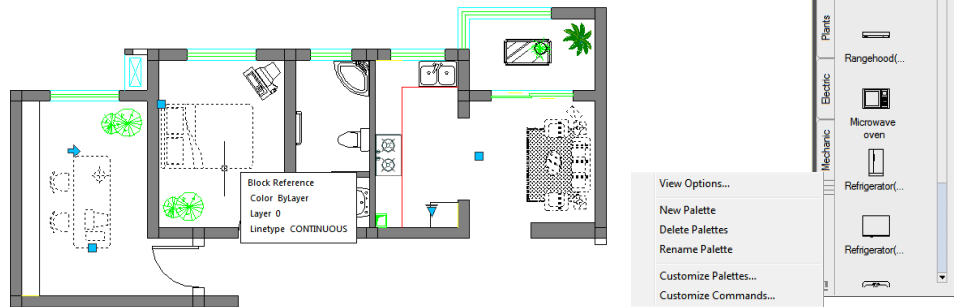

Design Center

With Design Center, you can organize access to drawings, blocks, text styles and other drawing contents:

- Browse for drawing content on your computer or a networked drive.
- View definition tables for named objects and then insert, attach, copy and paste the definitions into the current drawing.
- Create shortcuts to drawings and folders that you access frequently.
- Add content such as xrefs, blocks to a drawing.
- Drag drawings, blocks to a tool palette for convenient access

Folders Tab: The following icons are displayed in this tab: networks and computers, computer drives, folders, drawings and related support files, Xrefs, layouts and named objects, including blocks, layers, linetypes, text styles and dimension styles within a drawing.

Open Drawings: A list of currently opened drawings is displayed. If you click a drawing file and then click one of the definition tables, you can load the content into the content area.

History: A list of previously opened files is displayed. If you double-click a drawing file from the list, you can load the content into the content area.

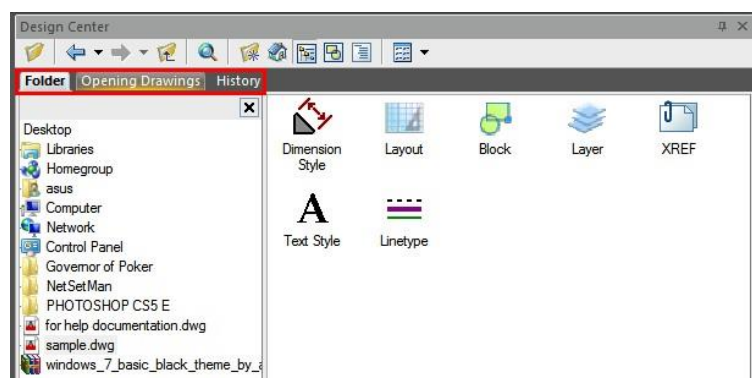

Favorites: If you have contents need to access quickly on a regular basis, the Design Center provides a solution to finding those. When you select any type of content, you can right-click and choose to add it to Favorites. In favorite folder you can save shortcuts to content on local drives, a network drives. The original file or folder doesn't move; but all shortcuts you create are stored in the Favorites folder.

Create, Open, Save and Recover a Drawing

Create a Drawing

Create a New Drawing Using Default Settings

When the system variables FILEDIA and STARTUP are set to 1, typing NEW at the command bar, it opens Startup dialog box, from which you can use Default Setting, Template or Wizard to create a new drawing.

You can select either imperial or metric units for the new drawing.

Imperial measurement system: The drawing uses internal default values with default boundary is 12 × 9 inches.

Metric measurement system: The drawing uses internal default values with default boundary is 429 × 297 millimeters.

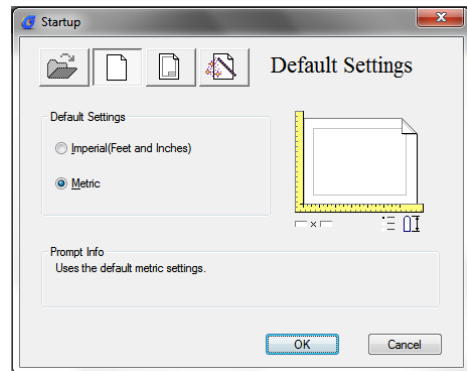

Create a New Drawing Using a Setup Wizard

From the Startup dialog box, you can select "Use a Wizard" tab to create a new drawing by the wizard. There are two wizard options illuminated as follows:

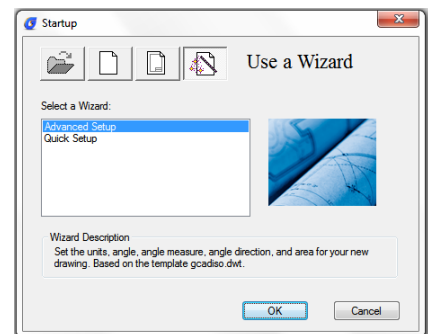

Advanced Setup Wizard:

From this option, you can set units of measurement, precision of displayed units, and grid limits. Also specify angle settings such as units of measurement style, precision, direction, and orientation based on template gcadiso.dwt.

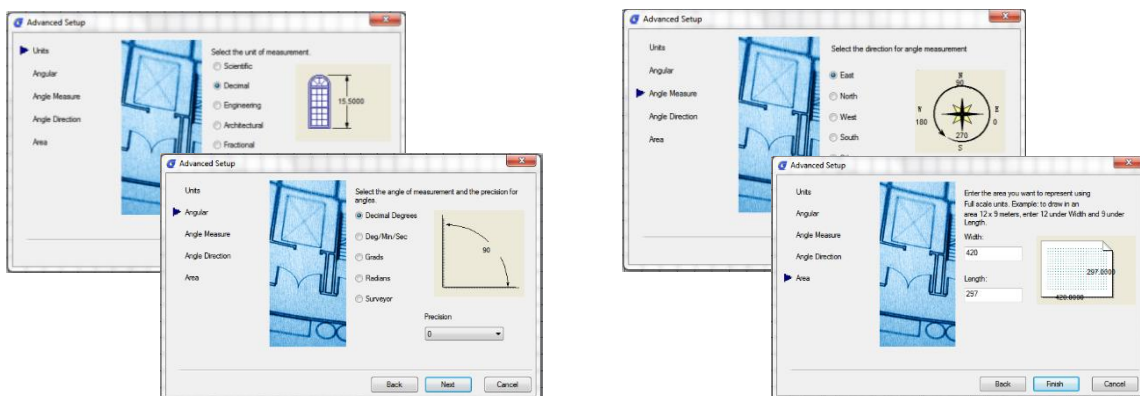

Quick Setup Wizard: From this option, you can specify units of measurement, precision of displayed units, and grid limits based on template gcadiso.dwt.

Create a New Drawing Using Template

When you need to create several drawings with the default settings, you can save time by creating a template file designed to create the same drawing files so that you does not need to specify default settings each time you start. Conventions and settings commonly stored in template files include: unit type and precision, title blocks, borders, and logos, layer names, snap, grid, and ortho settings, grid limits, dimension styles, text styles and Linetypes.

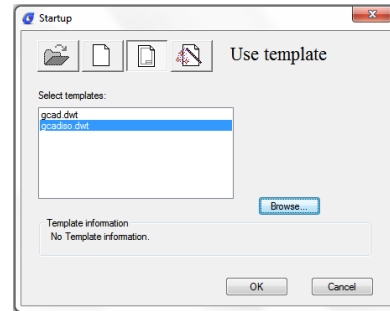

Also when the system variables FILEDIA and STARTUP are set to 1 and 0 separately, typing NEW opens Select Template dialog box, from which you can select the desired one or use the default template by clicking the arrowhead button next to the Open button.

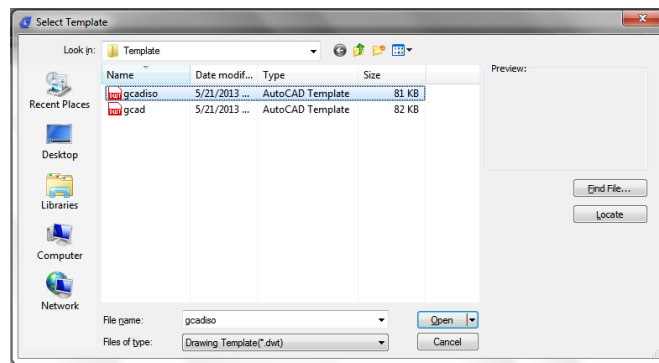

Open a Drawing

Open a Drawing

You can open drawing (.dwg) files, Drawing Exchange Format (.dxf) files and drawing template (.dwt) files. You can also open and check drawings that you suspect are damaged.

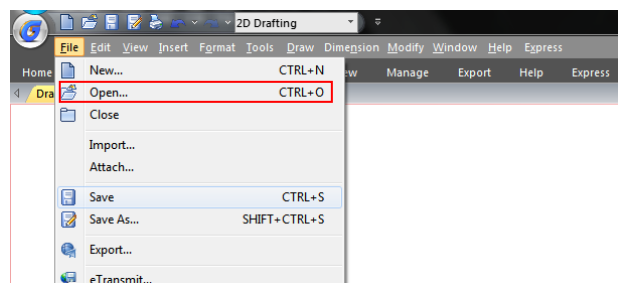

To open an existing drawing: File > Open Command line> OPEN Using shortcut> CTRL+O

- In the dialog box, choose the type of file you want to open.
- Choose the folder containing the desired file.
- Choose the drawing you want to open, and then click the Open button or Double click on the drawing you want to open.

Remark: If the drawing requires a password, enter the password, click OK to verify the password, and then click Open again.

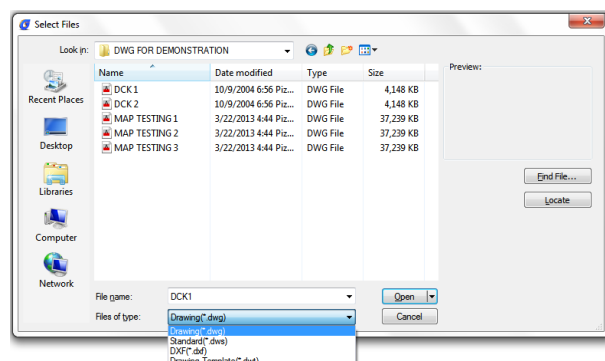

Multiple Open Drawings

You can open multiple drawings at one time. There are several methods for switching a drawing to another.

- Acting the drawing by clicking it or using shortcut keys of <Ctrl+Tab>.

-You can change the display styles to Cascade, Title Vertically or Title Horizontally from the Window menu. You can also use Arrange Icons to align icons if there are several minimum drawings.

Remark: The document switch preview function is only available after you opened three or more drawings.

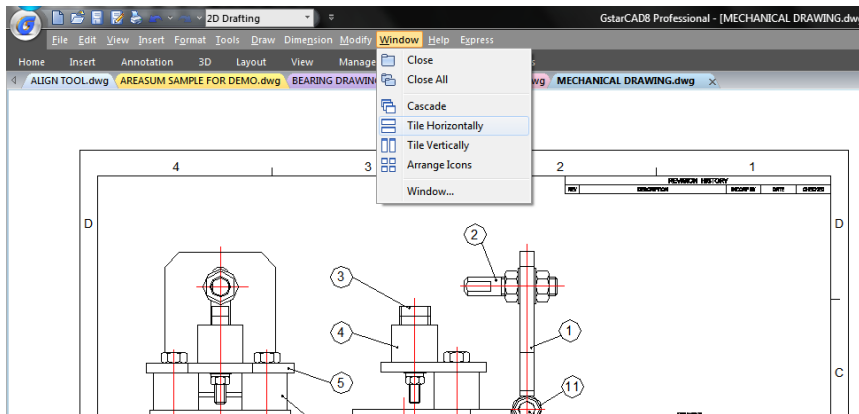

Save a Drawing

Save a Drawing

You save drawing files for later use. You can also set up automatic saving and backup files and save only selected objects. In addition, you can also save a drawing in a Drawing Exchange Format (.dxf) file or a drawing template (.dwt) file. If you created your drawing using a template, saving the drawing does not alter the original template.

To save a drawing: File > Save Command line> SAVE Using shortcut> CTRL+S

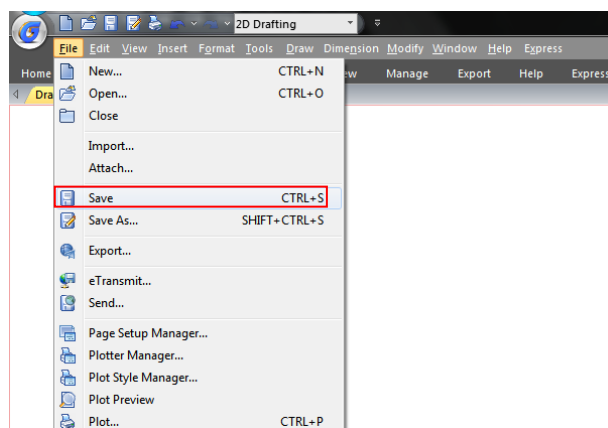

Remark: When you save a drawing the first time, the program displays the Save Drawing As dialog box so that you can choose a directory and type a name for the drawing.

Save Your Drawing Automatically

You can specify to save drawing files automatically in order to minimize the lost data once a problem occurs.

If you start the automatic save option, your drawing is saved at specified time intervals. By default, system assigned the name filename.ac\$ for temporarily saved files, filename here refers to current drawing name.

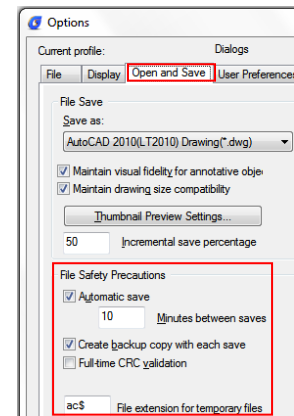

Save Part of a Drawing File

You can use BLOCK command or WBLOCK command to create a new drawing from part of an existing drawing. You can select entities or a block definition in your current drawing and save them in a new drawing file. The description also can be saved in the new drawing.

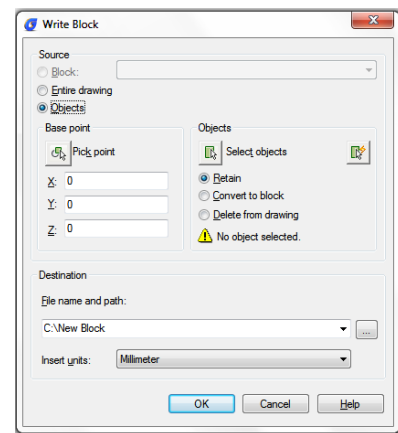

Save to a Different Type of Drawing File

Choose the format from Save as Type in the Save Drawing As dialog box, you can save a drawing to an earlier version of the drawing format (DWG) or drawing interchange format (DXF), or save a drawing as a template file.

To save a different format:

File > Save As Command line> SAVE AS
Using shortcut> SHIFT+CTRL+S

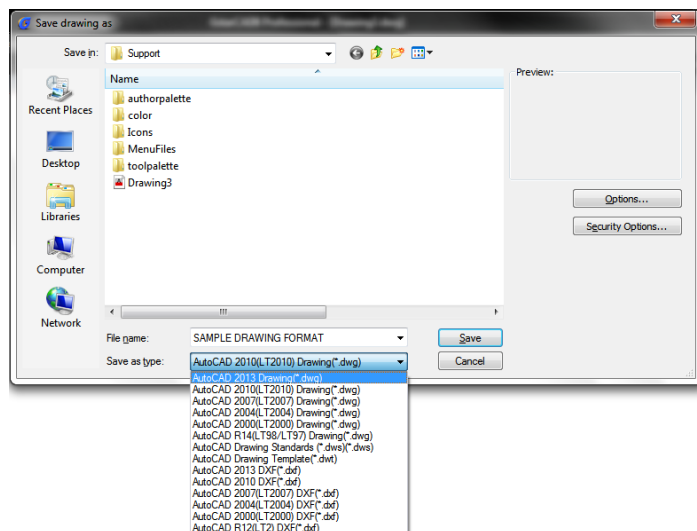

Use Backup Files

GstarCAD8 creates a backup file with the current drawing name and a ".bak" extension to save the previous version of the current drawing when launching "backup automatically" option.

Reduce the Time Required to Save a Drawing File

In order to reduce the time of saving a drawing file, you can specify the incremental save percentage on the Open and Save tab of Options dialog box or from the ISAVEPERCENT system variable.

The incremental save updates only the portions of the saved drawing file you changed. Drawing files will contain a percentage of potentially wasted space when you use incremental saves. This percentage increases after each incremental save until it reaches the specified maximum value, and then a full save is performed.

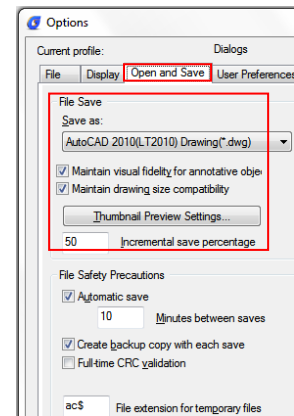

Recover a Drawing

Recover a Damaged File

You can recover some or all of data by reverting to a backup file or using commands to find and correct errors if a drawing file is damaged. A drawing file may be damaged by a hardware failure, power outage and system crash. You had better create a backup file if the drawing is important.

On the Open and Save tab of Options dialog box, you can specify the backup file are created when you save drawings and set the proper interval time for saving. Then a backup copy file with a ".bak" extension is created when you save the named drawing once again. After that, a backup file is always updated while you executing the command SAVE or SAVEAS.

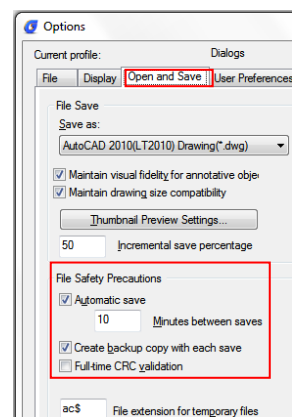

You can use RECOVER command to check and attempt to open a damage file. Then uses AUDIT command to find and correct errors.

To open a damaged file: File > Drawing Utilities> Recover Command line> RECOVER

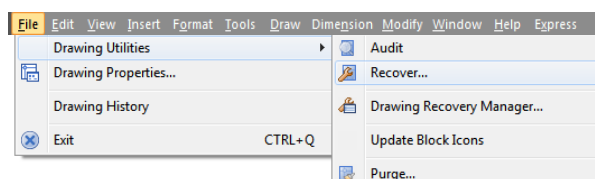

-In the dialog box at Files of Type, choose the type of file you want to recover.

-Choose the directory containing the damaged file.

-Choose the damaged file you want to recover and Click the Open button or Double click on the drawing you want to open.

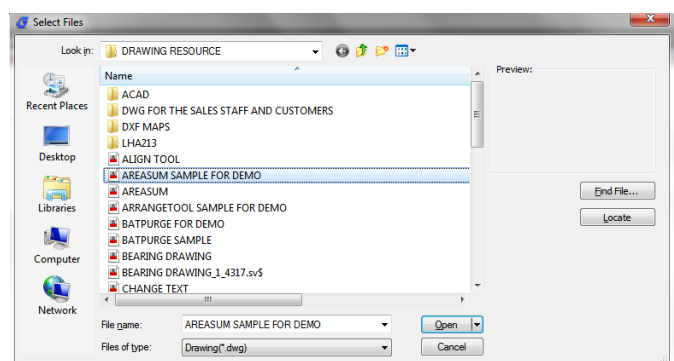

To check errors for a drawing file: File > Drawing Utilities> Audit

Command line> Audit

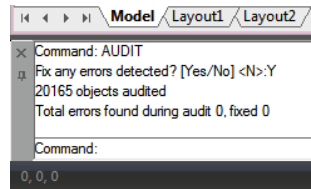
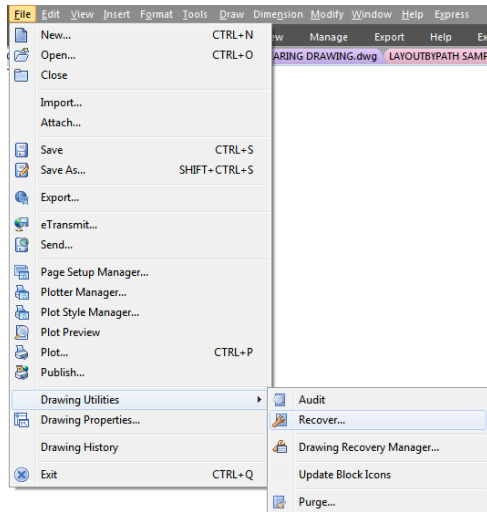

1. To choose from the opened drawing, click on File > Drawing Utilities > Audit
2. Input Y or N to determine whether to recover the errors that are automatically found by GstarCAD, and then press Enter.

Drawing Recovery Manager

Once terminated by hardware problems, power failure or software problems, the application is capable of backup the opened drawing file. At the next startup, the program starts "Drawing Recovery Manager" in which all of the auto-backup drawing files that have been closed accidentally will be displayed. You can open the file of your demand by double clicking at the Backup File list on the "Drawing Recovery", if there is any damage to the file, system attempts to recover the drawing in process of backup.

When program or system stopped by accident, the drawing files need to recover are sorted into the following types.

- Recovered drawing file saved when program fails (DWG)
- Auto saved file, so called "auto-save" file (ac\$)
- Backup file (BAK)
- Source drawing file (DWG)

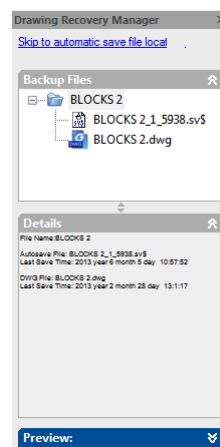

Control the Drawing Views

Redraw and Regenerate a Drawing

As you work on a drawing, visual elements may remain after the completion of a command. You can remove these elements by refreshing, or redrawing, the display.

To redraw (refresh) the current window display: View > Redraw Command line> REDRAW

To regenerate the current window: View > Regen Command line> REGEN

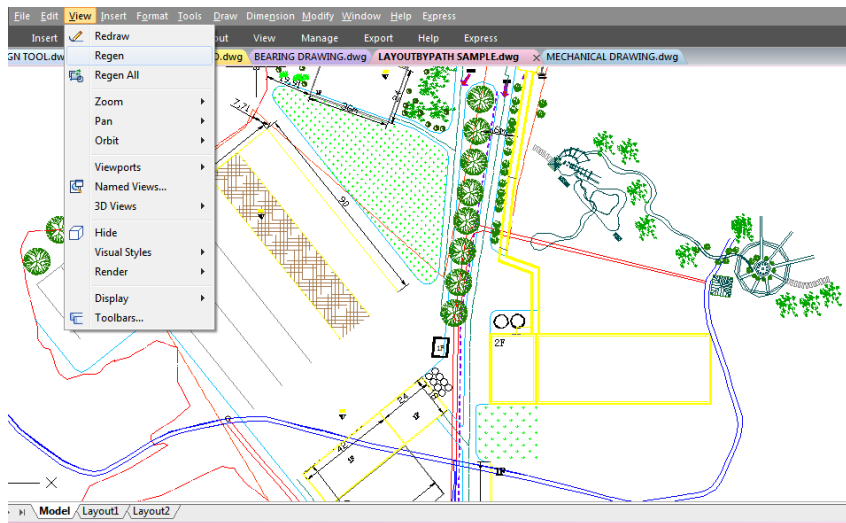

Information about drawing entities is stored in a database as floating point values, ensuring a high level of precision. Sometimes a drawing must be recalculated, or regenerated, from the floating point database to convert those values to the appropriate screen coordinates.

Magnify a View (Zoom)

You can use ZOOM command to zoom in or zoom out the drawing view to meet your need. You can change the magnification of your drawing at any time. The cursor changes to a magnifying glass when a zoom tool is active. Zoom out to reduce the magnification so you can see more of the drawing, or zoom in to increase the magnification so you can see a portion of the drawing in greater detail.

Remark: If you are working in a layout viewport and cannot zoom, the layout viewport may be locked. The scale and view do not change in model space while panning or zooming in a locked layout viewport.

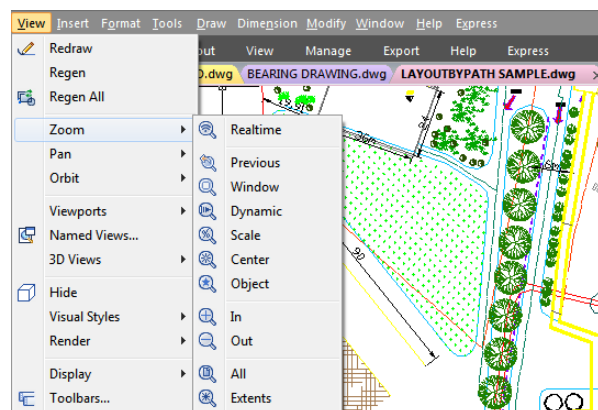

Zooming Methods

To zoom, you can use any of the following methods:

- To define the portion of the drawing to zoom, create a window.
- To zoom in real time, use the Zoom Realtime tool on the Standard toolbar.
- If you have a mouse with a wheel, rotate the wheel to zoom in and out.

Zoom to Magnify a Specified Rectangular Area

You can specify a rectangular area defined by two corners to display the objects within that area as large as possible. The lower-left corner of the specified area becomes the lower-left corner of the new view.

To zoom in to an area using a window: View > Zoom > Window Command line > ZOOM

- Choose View > Zoom > Window
- Select one corner of the window around the area you want to magnify.
- Specify the opposite corner of the window around the area you want to magnify.

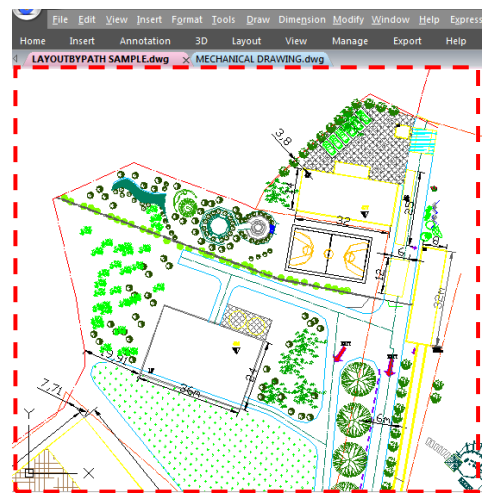
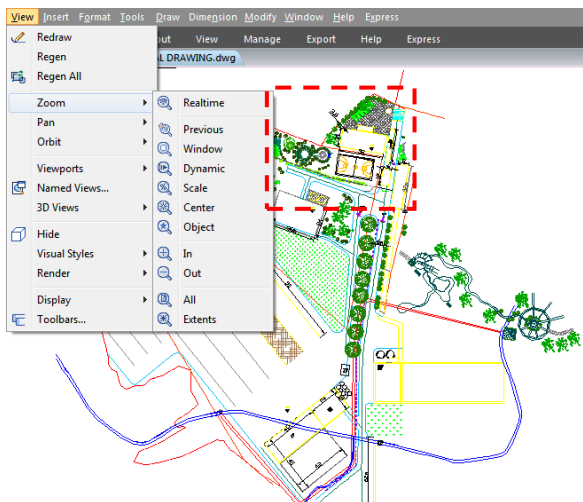

Zoom in Real Time

Realtime option zooms dynamically by moving your pointing device up or down. By right-clicking, you can display a shortcut menu with additional viewing options.

To zoom in real time: View > Zoom > Realtime
Command line > RTZOOM

- Choose View > Zoom > Realtime from the main menu.
- Hold the left mouse button, then drag the cursor forward to zoom in and move back to zoom out.

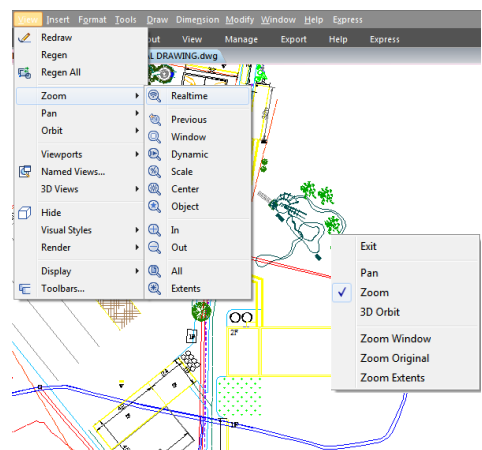

Displaying the Previous View of a Drawing

After you zoom in or pan to view a portion of your drawing in greater detail, you may want to zoom back out to see the entire drawing. On the View > Zoom menu, the Previous tool lets you restore the previous view. Selecting this tool repeatedly steps back through up to 25 successive zoomed or panned views.

Zooming to a Specific Scale

You can increase or decrease the magnification of your view by a precise scale factor measured relative to the overall size of the drawing or in relation to the current display. When you change the magnification factor, the portion of the drawing located at the center of the current viewport remains centered on the screen.

To zoom to a specific scale relative to the current display: View > Zoom>Scale Command line> ZOOM

- Choose View > Zoom > Scale from the main menu.
- On the Zoom toolbar, click the Zoom Scale.
- Type ZOOM in the command line, choose the Scale option, and then press Enter.
- Type the scale factor, followed by an x (such as 2x).
- Press Enter.

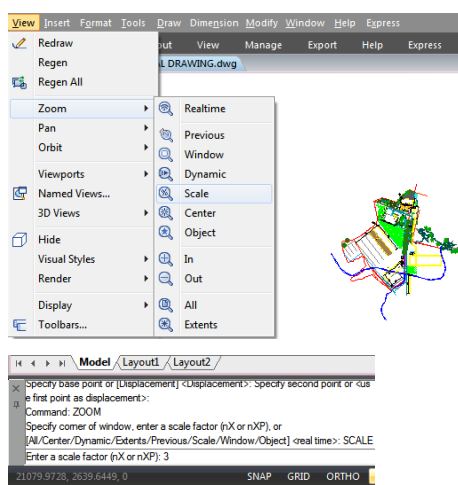

Displaying the Entire Drawing

ZOOM Extents option, displays a view that includes all of the objects in the drawing as large as possible. The view can display the objects on layers that are turned off but do not include objects on frozen layers.

ZOOM All option, displays all of objects within either the user-defined limits or the drawing extents, whichever view is larger.

You can use the Zoom All tool on the zoom toolbar to display an entire drawing. The Zoom Extents tool on the zoom toolbar displays the drawing to its extents, making the image fill the display to the greatest possible magnification.

Pan and View

You can move the drawing in any direction using the pan command. Panning shifts or slides the view of the drawing horizontally, vertically, or diagonally. The magnification of the drawing remains the same, as does its orientation in space. The only change is the portion of the drawing displayed. To pan, you can use any of the following methods:

- For precise panning, specify two points defining the magnitude and direction of the pan. The first point indicates the starting point of the pan. The second point indicates the amount of pan displacement relative to the first point.
- To pan in real time, use the Pan Realtime tool on the Standard toolbar.
- If you have a mouse with a wheel, press and hold the wheel, and then move the mouse.

To pan in real time: View > Pan>Realtime Command line> PAN

- Choose View > Zoom > Realtime from the main menu.
- Move the cursor in the direction you want to pan.
- To stop panning, press Enter, ESC or choose Exit from the shortcut menu.

To pan using a mouse with a wheel:

- Press and hold the wheel, and then move the mouse in the direction you want to pan (The MBUTTONPAN system variable controls this feature.)

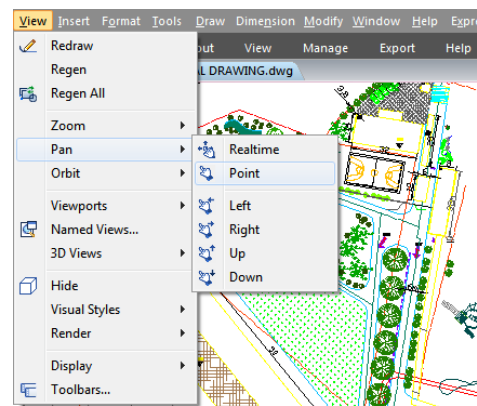

Display Multiple Views on Model Space

When you begin a new drawing, it is displayed in a single window. You can view the drawing in a second window, or you can divide one window into multiple windows. You can also open and display multiple drawings.

Set Model Space Viewports

The viewports created on the Model tab completely fill the drawing area and do not overlap. As you make changes in one viewport, the others are updated simultaneously. You can do the following operations at the model space viewport:

- Set Snap, Grid, and UCS icon modes; Pan; Zoom; and restore named views.
- Save orientations of UCS with individual viewports.
- When executing a command, you can draw from one viewport to another.
- Name a viewport arrangement in order to you can reuse it on the Model tab or insert it on a layout tab.
- When you work on 3D models, is helpful setting up different UCS in individual viewports.

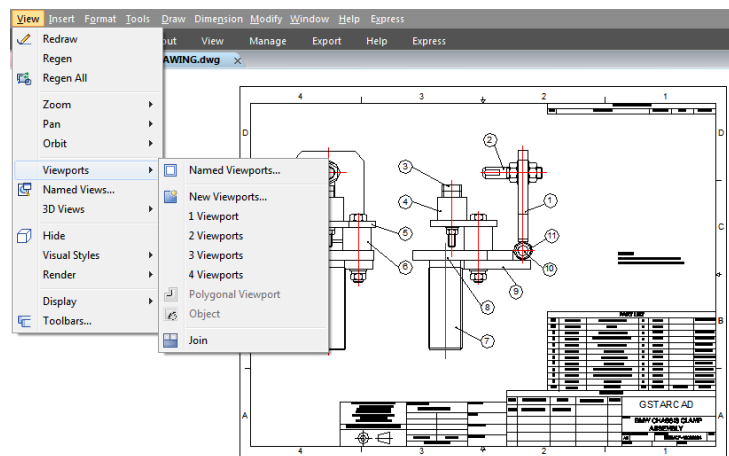

Working with Multiple Views of a Single Drawing

You can open and work with several views of the same drawing simultaneously. After you divide a single window into multiple windows, you can control each window separately. For example, you can zoom or pan in one window without affecting the display in any of the other windows. As you draw, any changes you make in one window are immediately visible in the others. And also you can switch from one window to another at any time.

To create multiple views: View > Viewports Command line> VPORTS

- Choose View > Viewports
- In viewports menu, choose 1, 2, 3, or 4 viewports.
- Type h if you want the horizontal orientation, or type v if you want the vertical orientation.

To join two views: View > Viewports> Join Command line> VPORTS

- Choose View > Viewports > Join
- Click anywhere inside the window you want to keep.
- Click anywhere inside the adjacent window you want to join to the first window.

To restore a named window configuration:

- Type -VPORTS system variable at the command line and press ENTER.
- Then type Restore.
- Then type the name of the window configuration you want to restore.

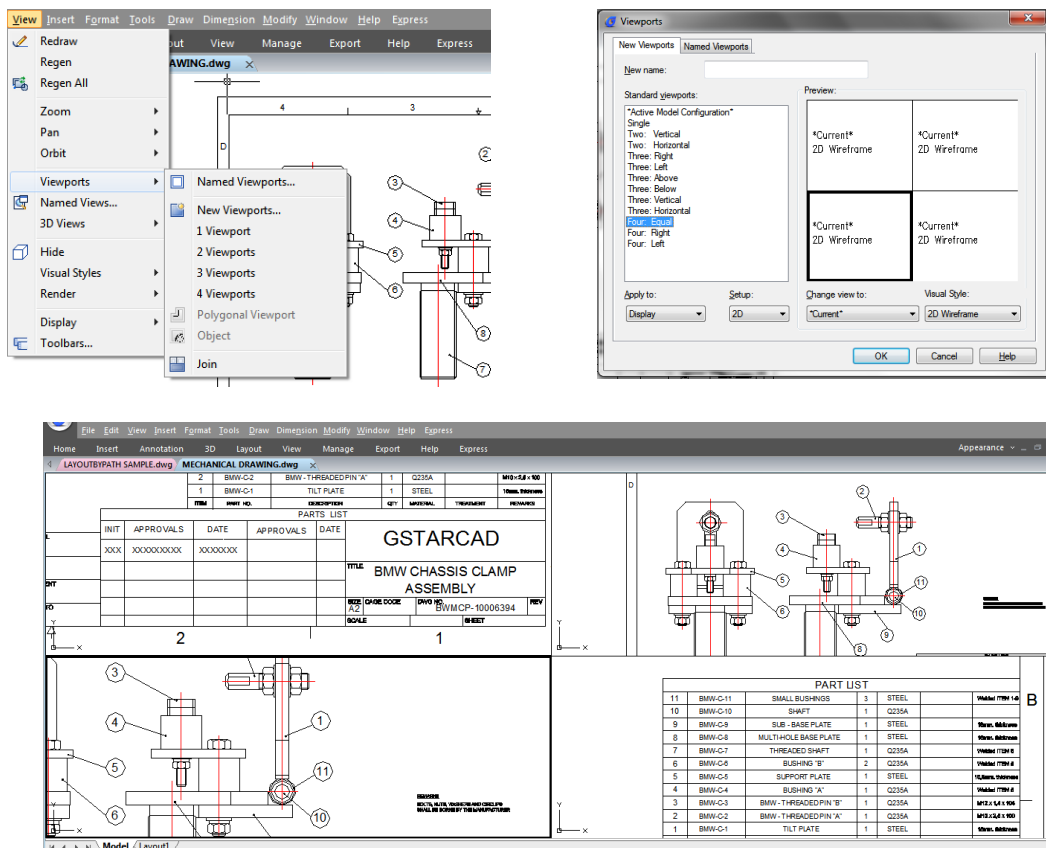

Working with Multiple Drawings

With the multiple document interface, you can open and work on several drawings at one time, you can copy, cut, or paste an entity from one drawing to another. Each drawing appears in a drawing window, which has the following advantages: You can see two or more drawings side by side, and you can easily copy entities from one drawing to another. Under the Window menu, the following three methods that determine how drawings are arranged are provided for user's choice.

- Cascade
- Tile Horizontally
- Tile Vertically

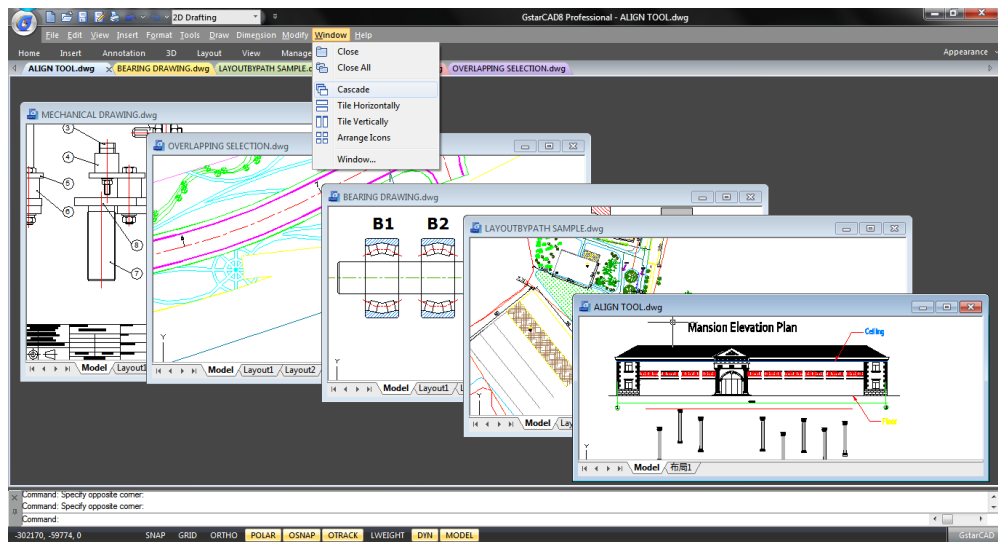

View Manager

With the view manager, you can create, set current, update layers, edit boundaries, and deletes named views, and switch quickly between each views, it is helpful to reduce many unnecessary view adjust operation.

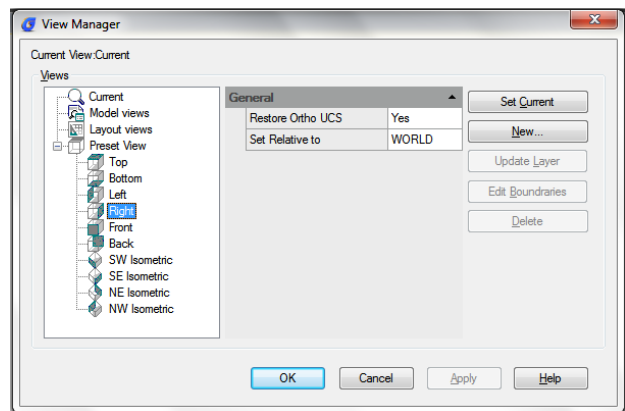

Specify a 3D View

You can set a 3D view to facilitate verifying the 3D effects of the drawing, constructing and visualizing 3D models. You can specify a new viewpoint to create new objects or modify the existing objects.

Set the Viewing Direction

You view three dimensional drawings by setting the viewing direction. The viewing direction establishes the viewing position, When you view a drawing from the default viewpoint (0,0,1), you see a plan view of the drawing. You can change the viewing direction to look at the drawing from a different vantage point or to work on a three dimensional model from a different orientation.

To set a new viewing direction:

View > 3D Views > Viewpoint Presets Command line > DDVPOINT

- Choose View > 3D Views > Viewpoint Presets
- Set viewing angles at absolute to WCS and relative to UCS by moving the position of the needle according to your preference. Then click OK button.

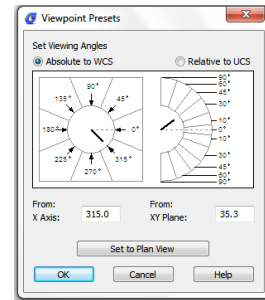

To display a plan view of the current drawing: View > 3D Views > Plan View Command line > PLAN

- Choose View > 3D Views > Plan View from the main menu.
- It concludes three plan views: Current UCS, World UCS and Named UCS. Choose one what you want.

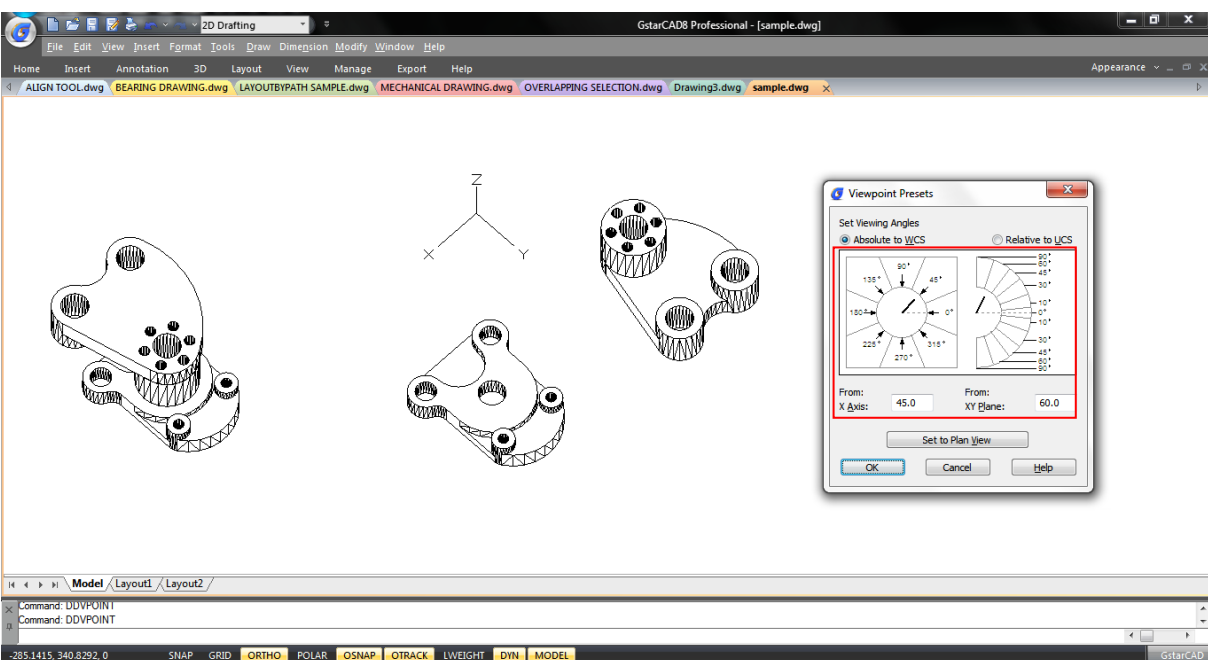
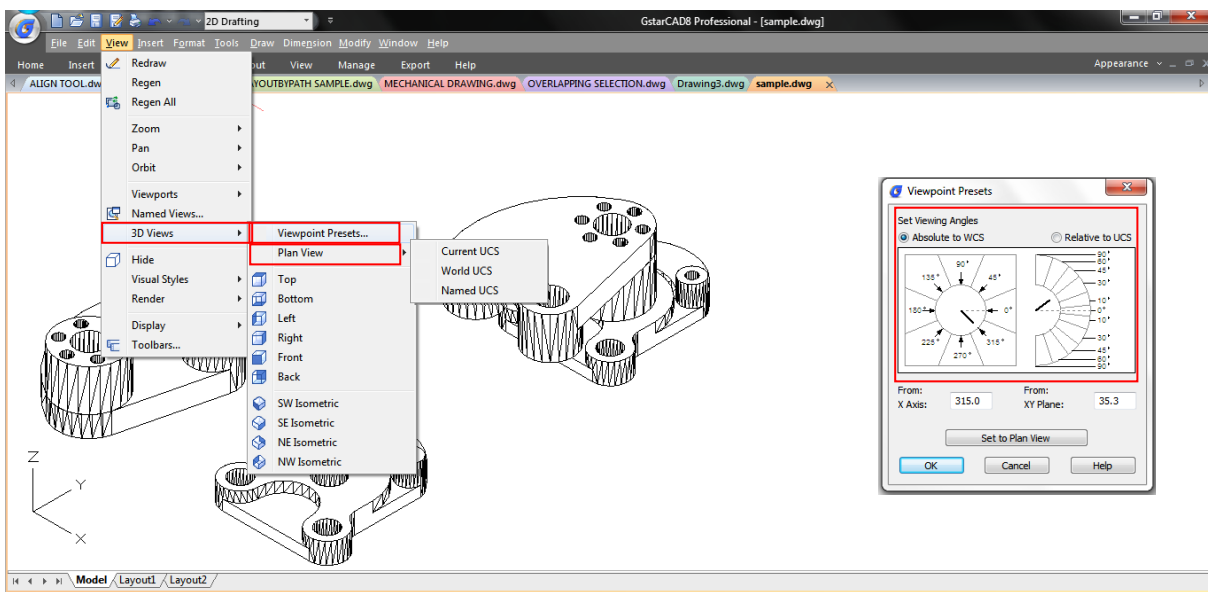

Isometric View

You can define perspective views of a model to create realistic effects. Select predefined standard orthographic and isometric views by name or description. These views represent commonly used options: Top, Bottom, Front, Left, Right, and Back. In addition, you can set views from isometric options: SW (southwest) Isometric, SE (southeast) Isometric, NE (northeast) Isometric, and NW (northwest) Isometric.

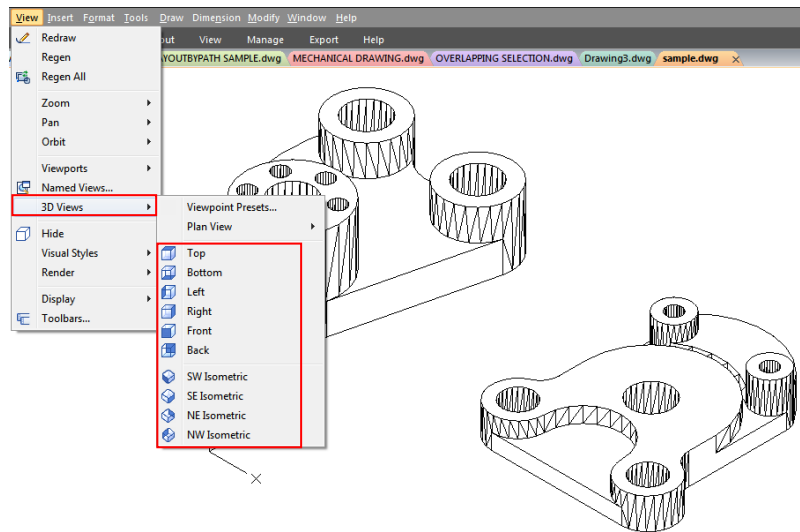

Draw 2D Isometric Views

With Isometric Snap, you can create 2D objects that appear to be 3D solids.

By setting Isometric Snap on the Draft Settings dialog box and turning on Snap and Grid, you can easily align objects along one of three isometric planes. However, although the isometric drawing looks like 3D, it is actually a 2D representation.

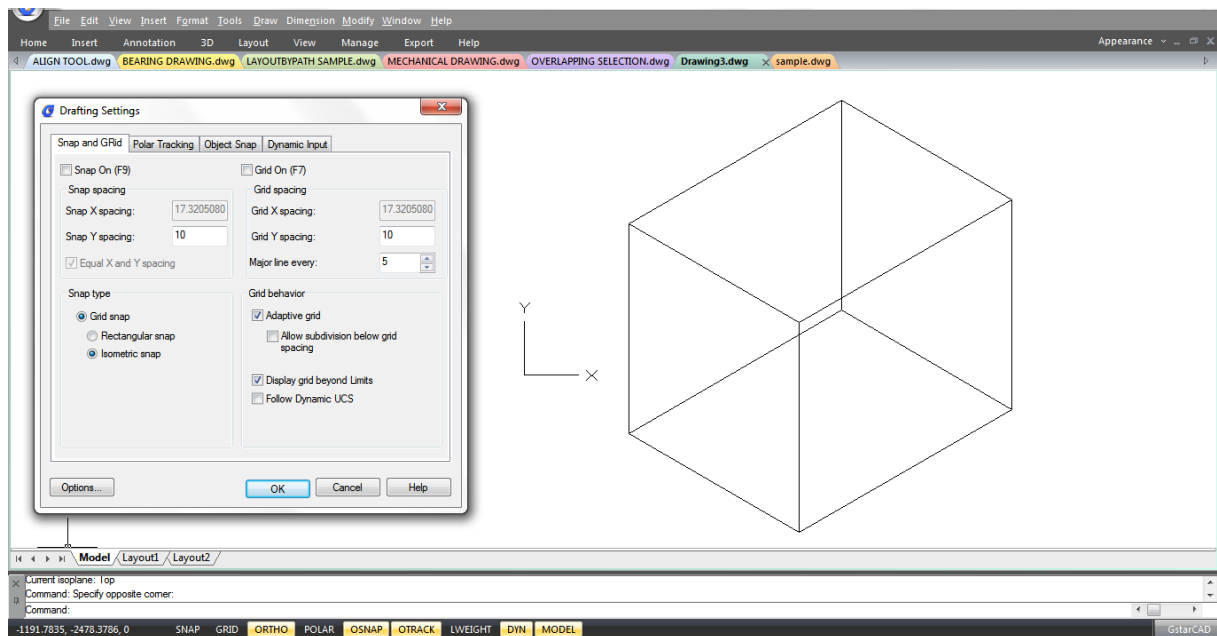

Set Isometric Grid and Snap

By aligning along three major axes, isometric drawing simulates a 3D drawing from specified viewpoint. When the snap angle is set to 0, the axes of the isometric plane are 30 degrees, 90 degrees and 150 degrees. With Isometric Snap on, you can work on any of three isometric planes, each with a pair of associated axes.

-Left. The left isometric plane defined by a pair of 90- and 150-degree axes. The snap and grips align along the 90- and 150-degree axes.

-Top. The top isometric plane defined by a pair of 30- and 150-degree axes. The snap and grips align along the 30- and 150-degree axes.

-Right. The right isometric plane defined by a pair of 90- and 30-degree axes. The snap and grips align along the 90- and 30-degree axes.

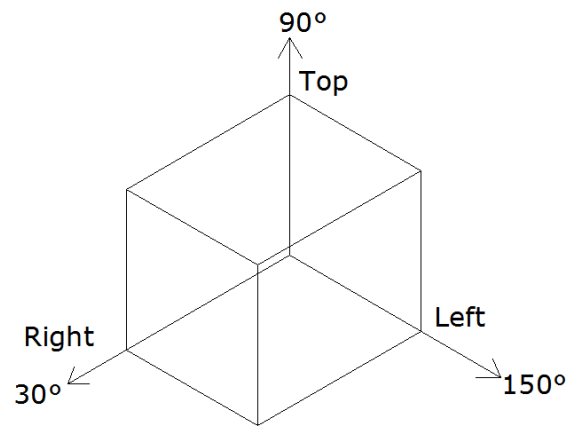
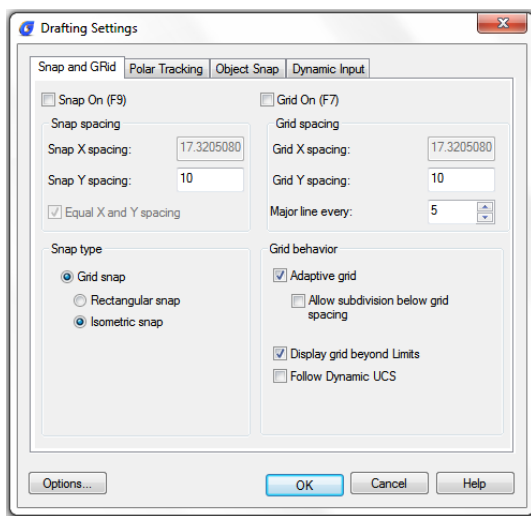

In addition to using ISOPLANE command to switch isometric planes, you can also use shortcut key F5 or CTRL+E. specifying one of the three isometric planes results in Ortho and crosshairs to be aligned along the corresponding isometric axes.

For example, when Ortho is on, the points you specified align along the simulated plane you are working on. Therefore, you can draw the top plane first, and switch to the left plane to draw another side, and then switch to the right plane to complete the drawing.

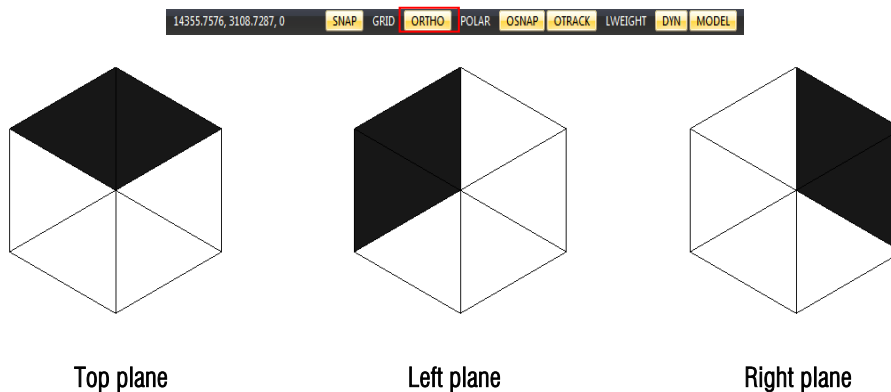

Change a 3D View Dynamically

You can view objects from any viewing direction by holding down mouse or other pointing devices and moving dynamically. With dynamic viewing, you can display the effects of changing viewpoint while you change the view. You can execute move or zoom operations as the 3D Orbit is active. When the 3D Orbit is active, you are not allowed to modify objects. To close 3D Orbit, press Enter, ESC or choose Exit from the shortcut menu.

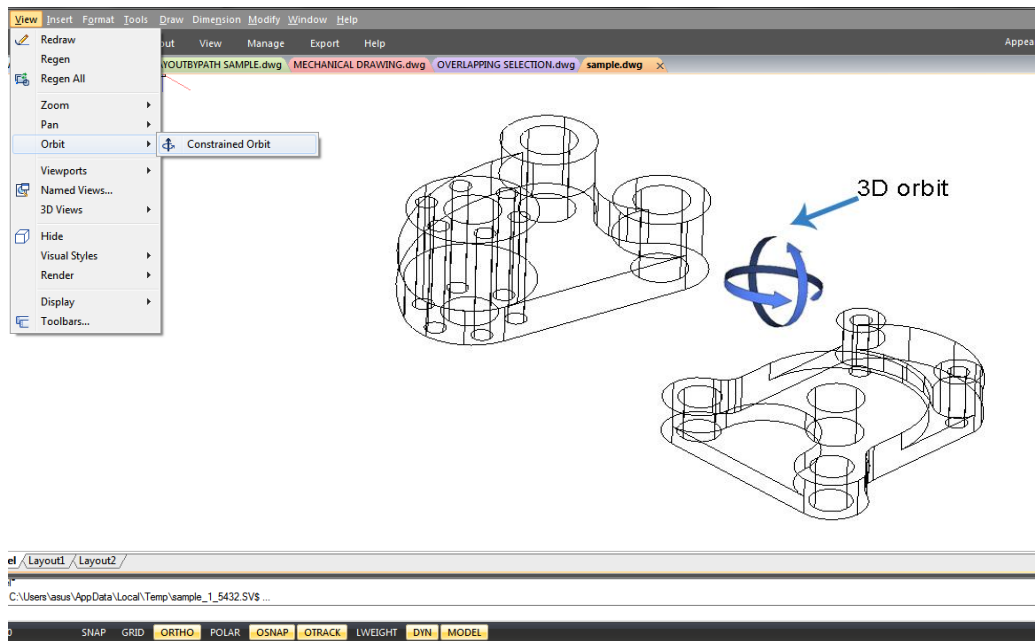

Hide Lines or Shade 3D Objects

Hides or shades for 3D objects in the current drawing, suppresses the display of the objects (partly or entirely) that are located behind other objects, or generates a simply shaded image displayed in the current view. You can use HIDE command to remove the hidden lines to verify the current placement of these surfaces. Hiding background lines makes the display much clearer, but you cannot modify hidden-line or render views.

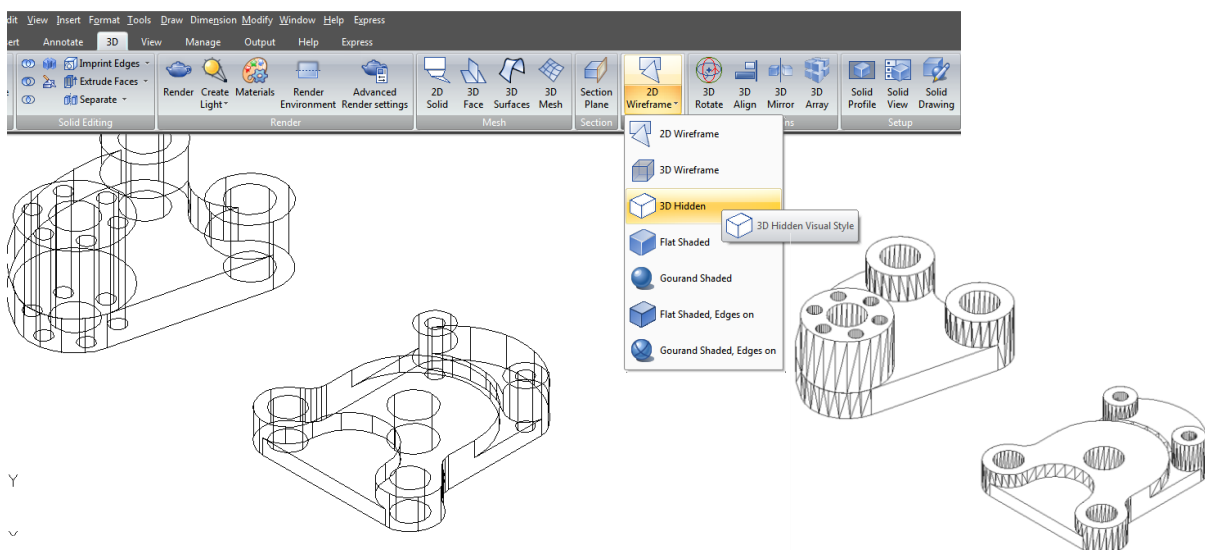

Add Simple Shading to 3D Objects

Although hiding lines can enhance the drawing and clarifies the design, shading produces a more realistic image of your model. You can modify shaded objects as you normally would. When a shaded object is selected, the wireframe and grips appear on top of the shading.

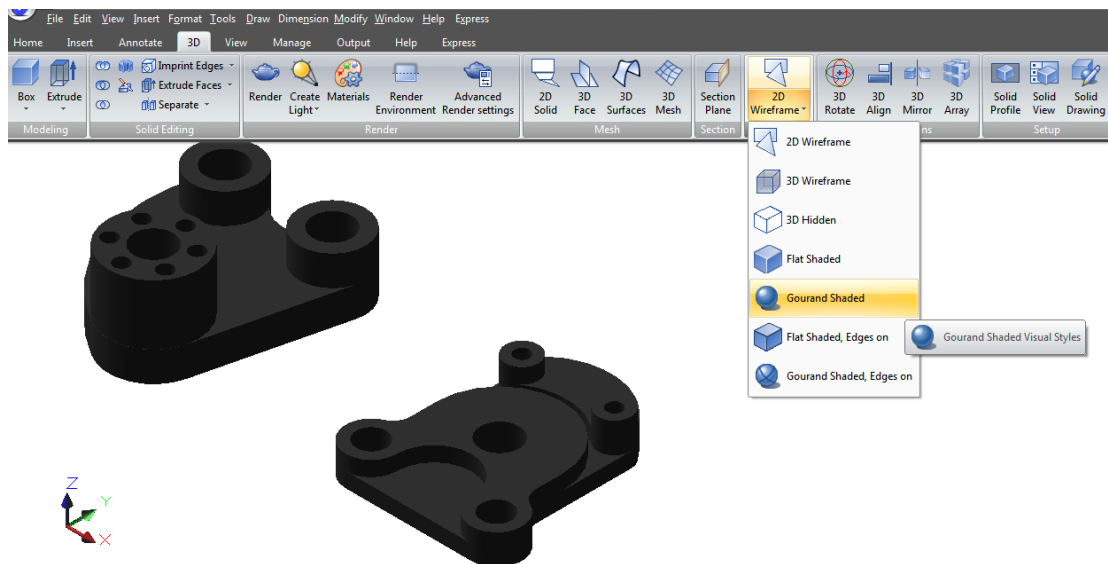

Render

Rendering creates a 2D image based on a 3D scene. It shades the scene's geometry using the lighting you've set up, the materials you've applied, and environmental settings such as background and fog. At a basic level, you can use the render command to render your model without applying any materials, adding any lights, or setting up a scene. You cannot move or adjust this light.

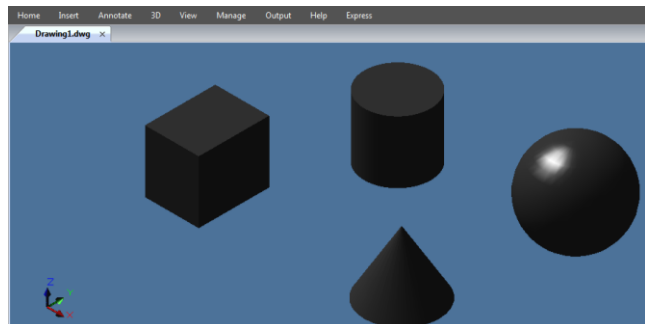

Render Environment

You can use environmental features to set up atmospheric effects or background images. You can enhance a rendered image by means of atmospheric effects like fog and depth cueing or by adding a bitmap image as a background. Fog and depth cueing are actually two extremes of the same effect: a white color is fog, and a black color is traditional depth cueing. You can use any color in between.

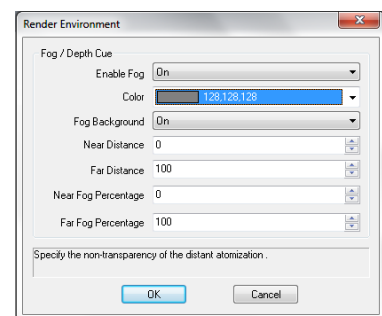

Light

Lighting adds the finishing touch to the scene. You can add point lights, spotlights, and distant lights and set the location and photometric properties of each.

Point Light: A point light radiates light in all directions from its location and does not target an object.

Spotlights: A spotlight can be directed towards an object.

Distant Lights: Simulates the effect of sunlight and can be used to show how the shadows cast by a structure affect the surrounding area.

Light List: Displays a list of type and light name used in model. Distant lights and the sun do not appear as interface objects in the model.

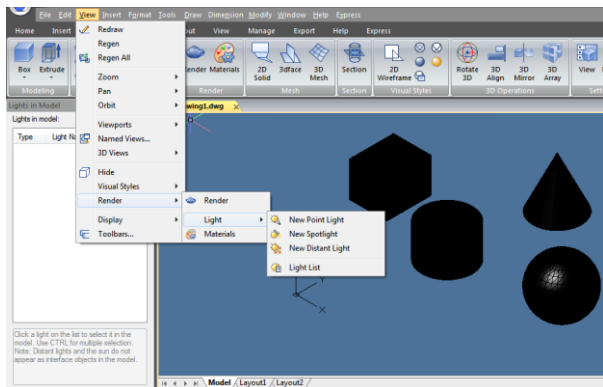

Materials

You can add materials to objects in your drawings to provide a realistic effect. In the context of rendering, materials describe how an object reflects or transmits light. Within a material, maps can simulate textures, bump effects, reflections, or refractions.

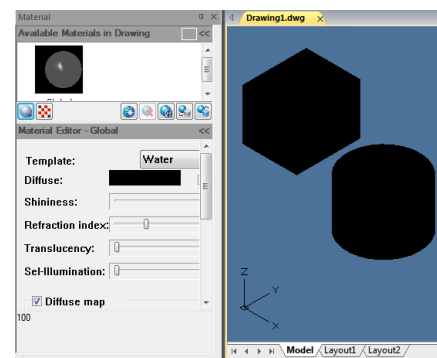

Precision Tools and the Properties of Drawings

Specify Units, Angles and Scale

Specify the units of measurement you want to use, their format, and other conventions.

Set the Units Format

You can set the display format of the unit that includes: scientific, decimal, engineering, architectural and fractional notation. To enter architectural feet and inches format, you can indicate feet using the prime symbol ('), for example, 72'3". You do not need to specify inches by entering quotation marks ("). You can set the unit type and precision in the Quick Setup wizard, the Advanced Setup wizard, or the Units Control dialog box. These settings control how your coordinate, offset, and distance entries are interpreted, and how coordinates and distances are displayed.

To open drawing units dialog: Format > Units Command line> UNITS

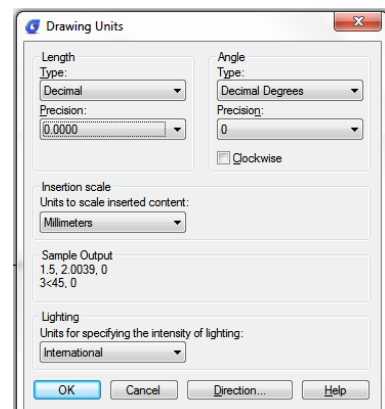

Set Angle Conventions

You can specify the location for angle 0 and the positive direction for the angle measurement: clockwise or counterclockwise. You can also specify the format and the number of decimal fraction.

-Specify the measurement unit and precision: The units include grad, radian, surveyor's unit and degree, minute and second.

-Specify where the angle measurement starts from: east, west, south, north or others. For example, to enter a coordinate relative to the current coordinate for a property line that is 54 feet, 7 inches long with a bearing of 60 degrees north, 12 minutes, 6 seconds east, enter @54'7" <n60d12'6"e.

-Specify the positive direction: counterclockwise or clockwise. The angle 0 can be set to any location.

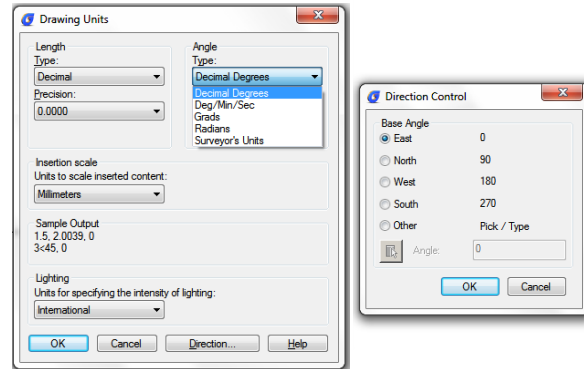

Setting Scale Factors

Instead of drawing to a particular scale, you draw everything full size in the program. When you print your drawing, you can assign the scale at which the drawing is to print. Scale, however, does affect the way a few elements such as text, arrows, or linetypes print in your drawing. For example, when you draw text, you need to determine the text size so that when you print it later at a particular scale, the text height is correct.

After you determine the eventual scale of your finished drawing, you can calculate the scale factor for the drawing as a ratio of one drawing unit to the actual scale unit represented by each drawing unit.

The following table shows some standard architectural and engineering scale ratios and equivalent text heights required to create text that measures 1/8 inch high when you print the drawing at the specified scale.

You can use these scale factors to predetermine the size of your drawing to make sure that it fits on a specific size paper when you print it. You control the size of your drawing by the drawing limits. To calculate the drawing limits to match the size of your paper, multiply the dimensions of your paper size by your scale factor.

Standard scale ratios and equivalent text heights		
Scale	Scale factor	Text height
1/16" = 1'-0"	192	24"
1/8" = 1'-0"	96	12"
3/16" = 1'-0"	64	8"
1/4" = 1'-0"	48	6"
3/8" = 1'-0"	32	4"
1/2" = 1'-0"	24	3"
3/4" = 1'-0"	16	2"
1" = 1'-0"	12	1.5"
1 1/2" = 1'-0"	8	1"
3" = 1'-0"	4	0.5"
1" = 10'	120	15"
1" = 20'	240	30"
1" = 30'	360	45"
1" = 40'	480	60"
1" = 50'	600	75"
1" = 60'	720	90"
1" = 100'	1200	150"

Drawing Limits

You can specify the drawing limits that form an invisible boundary around your drawing. You can use the drawing limits to make sure that you do not create a drawing larger than can fit on a specific sheet of paper when printed at a specific scale.

For example, if you plan to print your drawing at 1/8" = 1'-0" (in other words, using a scale factor of 96) on a sheet of paper measuring 36 inches x 24 inches, you can set drawing limits to 3,264 units wide (that is, 34 x 96) and 2,112 units high (22 x 96), which allows a 1-inch margin around the edges of the printed image.

To set the drawing limits: Format > Drawing limits

Command line> LIMITS

-Choose Format > Drawing Limits

-Specify the x-coordinate and y-coordinate of the upper right drawing limit and the lower left drawing limit. You can also click Select to specify the drawing limits by selecting points in the drawing.

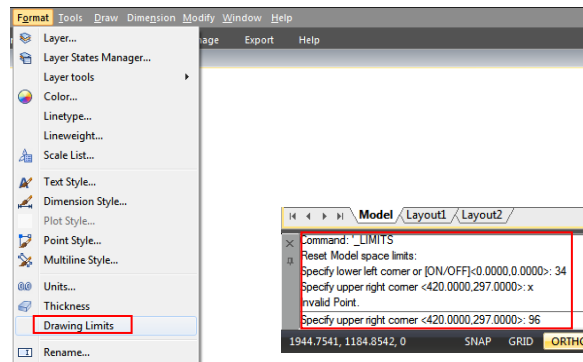

Grid and Grid Snap

The grid in GstarCAD8, is a rectangular pattern comprised of minor and major lines extended over the drawing area. Displaying grids and using grids snap improve the performance of regenerating. When you turn Snap mode on, the cursor adheres or snaps to the invisible grids. Grid and snap settings are effective tools to use in your drawing to ensure accuracy. In addition, the cursor can be restricted to move orthogonally only or guides can display on the screen automatically at specified polar angle increments.

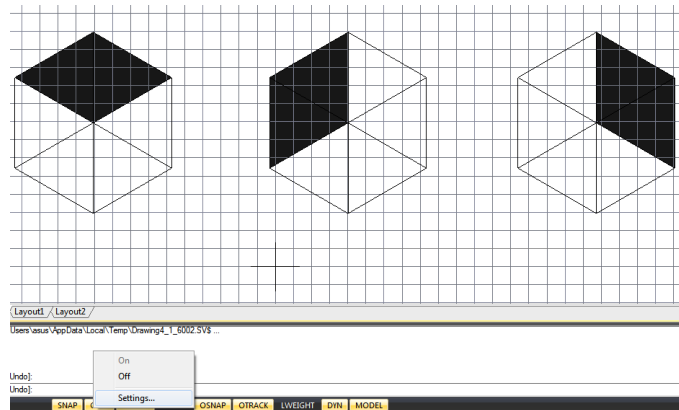

Change Grid and Snap Spacing

You can turn Grid and Snap on and off and specify their spacing on the Snap and Grid tab at the Drafting Settings dialog box. Grid spacing does not have to match snap spacing. A wide grid spacing can be used as a reference while a closer grid spacing helps you specify points accurately.

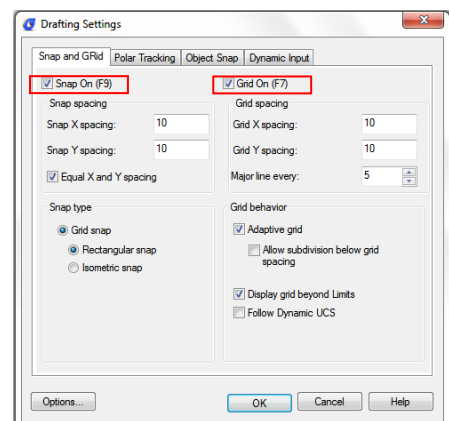
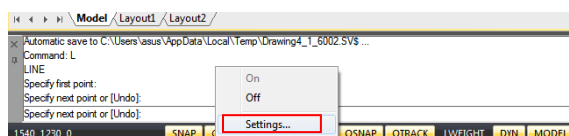

Use Object Snaps

Object snaps enable you to quickly select exact geometric points on existing entities without having to know the exact coordinates of those points. With object snaps, you can select the endpoint of a line or arc, the center point of a circle, the intersection of any two entities, or any other geometrically significant position. You can also use object snaps to draw entities that are tangent or perpendicular to an existing entity.

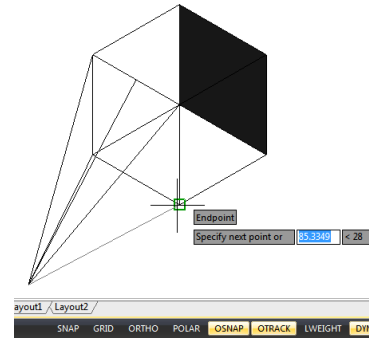

Setting Object Snaps

You can set object snaps using any of the following methods:

- Choose Tools > Drafting Settings > Object Snap, and then click one of the object snap tools.
- On the Object Snap toolbar, click one of the object snap tools.
- On the status bar, right-click on the Object Snap button to choose Settings.
- Press and hold down the Shift key while right clicking anywhere within the drawing window to display the object snap shortcut menu, and then choose the object snap you want to set.

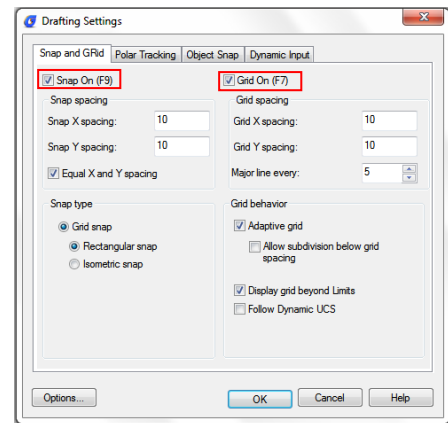

AutoSnap Tools

The automatic snap tool is a visual aid tool for snapping that help you see and use object snaps more efficiently. When any object snap is on, the system displays a marker and a tooltip when you move your cursor on over a snap point. AutoSnap turns on automatically when an object snap is on. By default, AutoSnap marker, tooltip and magnet are on. You can change the settings of AutoSnap on the Options dialog box. AutoSnap consists of the following snap tools:

-Marker. The object snap location is displayed when the cursor moves over or near an object. Marker shape is determined by the snap it is marking.

-Tooltip. Indicates which part of the object you are snapping to in a flag at the cursor location.

-Magnet. Attracts and locks the cursor onto the nearest detected snap points. Provides a visual that is similar to snapping to a grid.

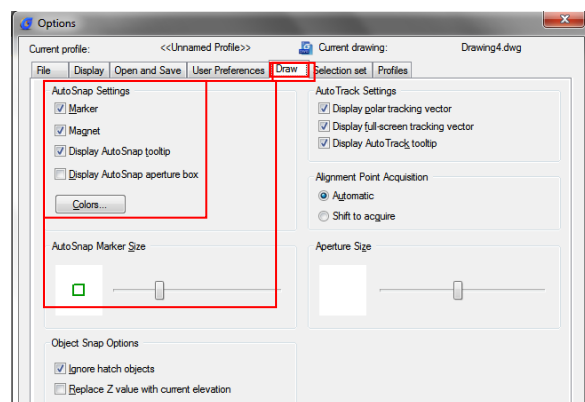

-Aperture box. Surrounds the crosshairs and defines an area within which, when you move the cursor, system evaluates objects for object snaps. You can determine the aperture box is displayed or not, and the aperture box size can be changed too.

Use Polar Tracking and Object Snap Tracking

Auto tracking includes polar tracking and object snap tracking. You can turn them on and off by repressing POLAR and OTRACK buttons on the Status Bar. When the polar tracking mode is on, the cursor moves along the specified angle. When the object snap tracking is on, the cursor moves along an alignment path based on the snap point.

Polar Tracking

When polar tracking is turned on, guides display on the screen automatically at the polar angle increment that you specify. For example, if you draw a line with polar tracking turned on with angle increment set as 65 degrees, the rubber-banding line displays at 65 degree increments.

To enable polar tracking and specify the polar angle increment:

1. Do one of the following:

- Choose Tools > Drafting Settings from the main menu.
- On the Object Snap toolbar, click the Object Snap Settings button.
- Type DSETTINGS in the command line and then press Enter.

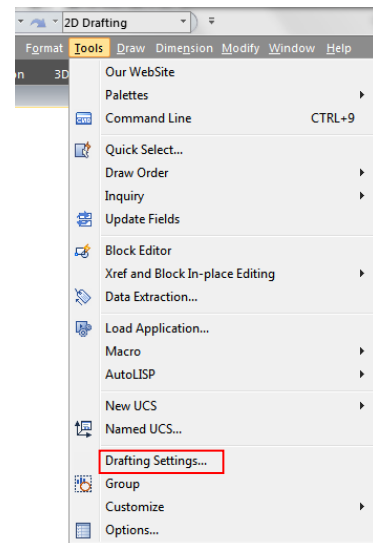

2. Switch to the Polar Tracking tab.

3. Select the Polar Tracking On checkbox.

4. Do one of the following to specify the polar angle increments:

- Select an angle from the Increment Angle drop-down list.
- Mark the Additional Angles check box and click New to define a custom angle increment.

5. Click OK.

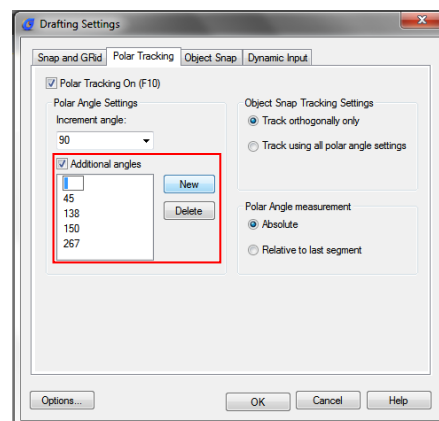
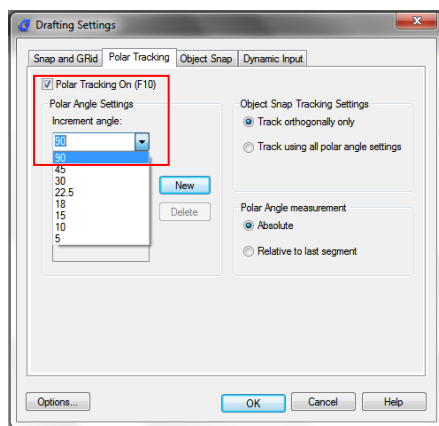

Remark: To toggle polar tracking on and off at any time, click the Polar Tracking button on the status bar or press F10.

To draw objects using polar tracking:

-Turn on polar tracking and start a drawing command, such as ARC, CIRCLE, or LINE. You can also use polar tracking with editing commands, such as COPY and MOVE.

-As you move your cursor to specify points, notice the dotted polar tracking line that appears at the tracking angles you specified. Points you specify while the line is displayed conform to the polar tracking angle.

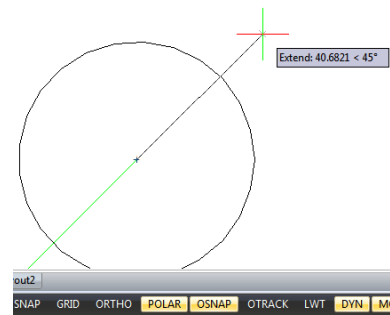

Object Snap Tracking

Object snap tracking can track along alignment paths that are based on object snap points and display tooltips at the acquired points. After you acquire a point, horizontal, vertical and polar alignment paths relative to the point are displayed when the cursor moves over their drawing path. For example, you can specify a point along a path that is based on an object endpoint or midpoint or an intersection between objects.

You can also use system variable TRACKPATH to control the display of polar and object snap tracking alignment paths.

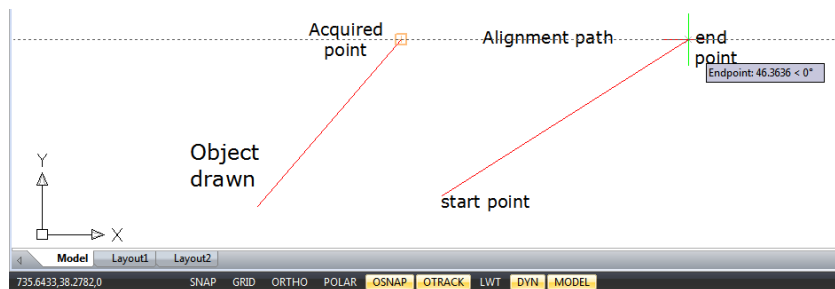

Use Orthogonal (Ortho Mode)

You can restrict cursor movement to the current horizontal and vertical axes so that you can draw at right angles, or orthogonally. For example, when the Draw Orthogonal option is enabled, lines are restricted to 0 degrees, 90 degrees, 180 degrees, or 270 degrees. As you draw lines, the rubber banding line follows either the horizontal or vertical axis, depending on which axis is farthest from the cursor. When you enable the isometric snap and grid, cursor movement is restricted to orthogonal equivalents within the current isometric plane. Ortho mode and polar tracking cannot be on at the same time. Turning on Ortho turns off polar tracking.

To fast enable orthogonal drawing:

-Press F8 or press the ORTO button at the status bar

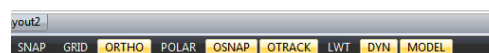
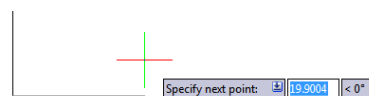

Working with Linetypes

A linetype is a repeating pattern of dashes, dots, and blank spaces displayed in a line or a curve. You can assign linetypes to objects by layer, or by specifying the linetype explicitly. And also, you can specify its scale, load more linetypes into the program from a linetype library file, and create your own custom linetypes.

By default, every drawing has at least three linetypes: CONTINUOUS, BYLAYER, and BYBLOCK. You cannot rename or delete these linetypes.

Remark: You should not confuse these linetypes with the hardware linetypes provided by some plotters. Both linetypes of dashes produce the similar effects. However, if you use both linetypes at the same time, the results can be unpredictable.

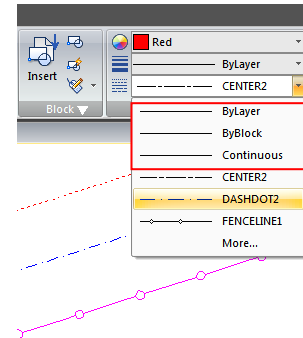

Load Linetypes

GstarCAD includes the linetype definition files gcad.lin and gcadiso.lin. If you select gcadiso.lin, you can use ISO pen-width option when you plot. If you want to know what linetypes are already available, you can display a list of linetypes that are loaded in the drawing or stored in an LIN (linetype definition) file. Both linetype definition files contain several complex linetypes.

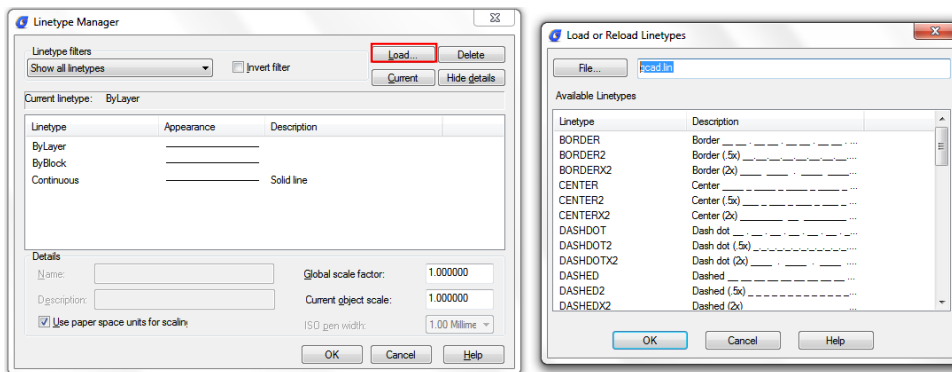

Change the Linetype of an Object

You can change the linetype of an object by changing the linetype of the layer the object is on, reassigning the object to another layer, or by specifying a linetype for the object directly.

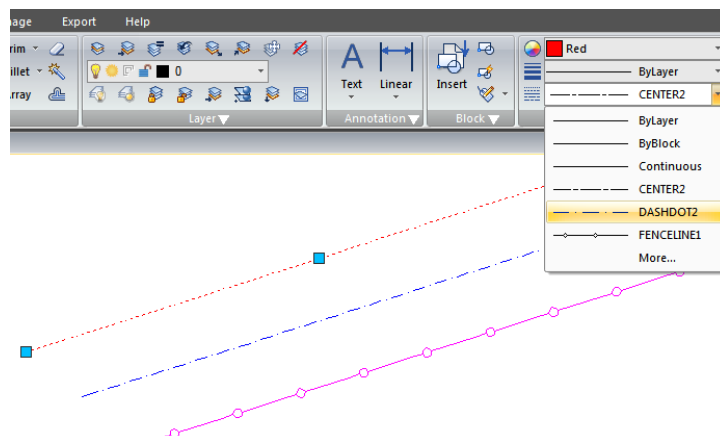

Set the Current Linetype

By default, all objects are created using the current linetype, which is displayed in the Linetype Control on the Properties toolbar. To modify this current linetype, you can select a linetype and make it current in the Linetype Manager dialog box. If the current linetype is BYLAYER, objects are created using the linetype assigned to the current layer.

If the current linetype is BYBLOCK, objects are created using CONTINUOUS linetype until they are grouped into a block. When you insert the block, it acquires the current linetype setting.

To make the linetype current:

Select a linetype from the Linetype Control pull-down list on the Properties toolbar, which is set to the current linetype.

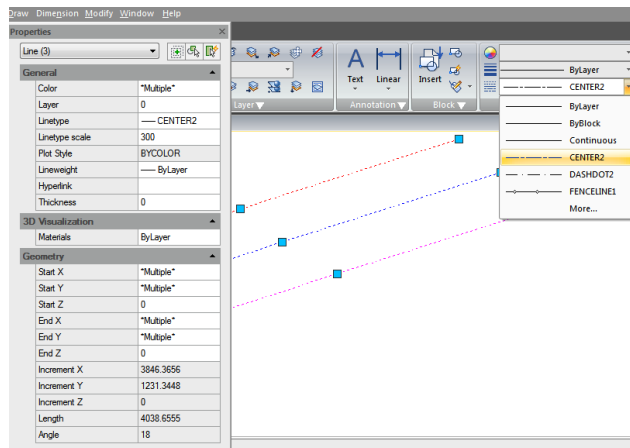

Control Linetype Scale

You can set global or individual scales for objects to control the display of linetypes. The Global Scale Factor and Current Object Scale are displayed in the Linetype Manager. The Global Scale Factor value is stored in the system variable LTSCALE, which changes the linetype scale globally for new and existing objects.

The Current Object Scale is stored in the system variable CELTSCALE, which specifies the linetype scale for new objects. In a layout, you can use system variable PSLTSCALE to adjust the linetype scale in different viewports.

Remark: Setting the linetype scale too large or too small may result in a line pattern looking like a solid line, depending on what the scale view is or at what scale the drawing is printed.

To set the current individual linetype scale: Format > Linetype Command line > LINETYPE

- Choose Format > Linetype
- Click the Show Details button.
- In the Current Object Scale field, type the linetype scale that you want to make current.
- Click OK.

To change the global linetype scale:

- Choose Format > Linetype
- Click the Show Details button.
- In the Global Scale Factor field, type the global linetype scale that you want to change. Then click OK button.

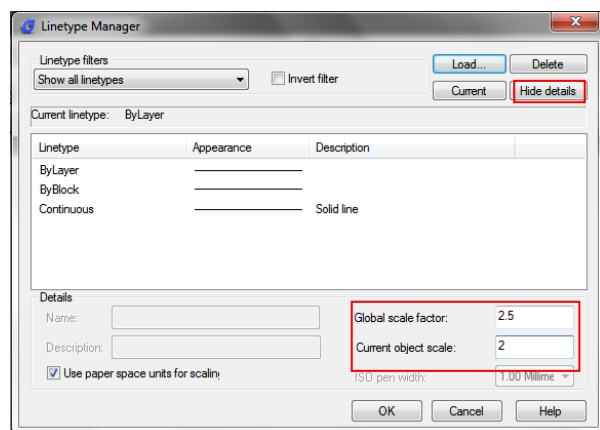

Working with Layers

Layers are like the transparent overlays you use in manual drafting. You use layers to organize different types of drawing information. Each object in a drawing exists on a layer. When you draw an object, it is created on the current layer.

Create and Name Layers

You can create an unlimited number of layers in every drawing and use those layers for organizing information. When you create a new layer, it is initially assigned the color white (or black, depending on your system settings) and the linetype CONTINUOUS. By default, a new layer is also visible. After you create and name a layer, you can change its color, linetype, visibility, and other properties.

To create a new layer: Format > Layer Command line> LAYER

- Choose Format > Layer
- Click the New Layer button.
- Type a name for the new layer and then click OK button.

To change a layer name in the current drawing:

- Choose Format > Layer
- In the Layer Properties Manager dialog box, click the name of layer you want to change.
- Type a new name and click OK button.

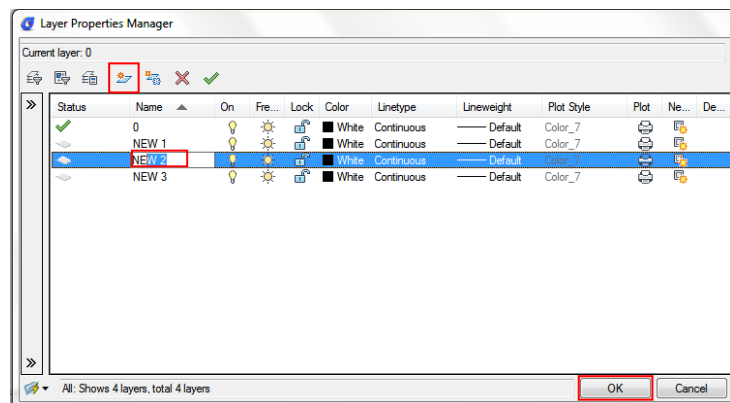

Setting the Current Layer

When you start a drawing, objects are created in the current layer. By default, the layer 0 is set to the current layer, but you can also create a new one and make it current. Any subsequent objects you create are associated with the current layer and use its color and linetype.

To make a layer current:

- Choose Format > Layer
- In the Layer Properties Manager dialog box, select a layer and then click the Set Current button to make the layer current.
- Click OK.

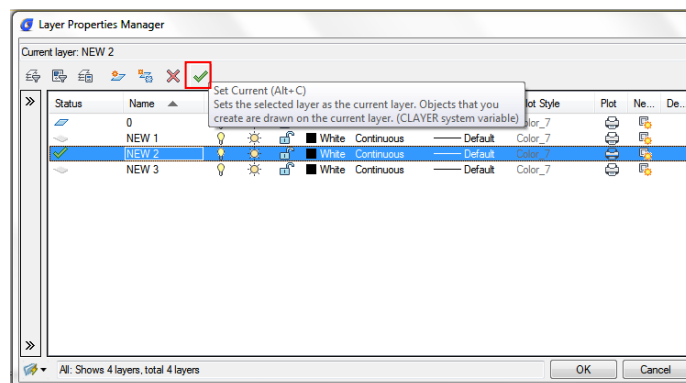

Removing Layers

You can remove unused layers from your drawing with PURGE or by deleting the layer from the Layer Properties Manager.

Controlling Layer Visibility

A layer can be visible or invisible. Objects on invisible layers are not displayed and do not print. By controlling layer visibility, you can turn off unnecessary information.

To turn layers on or off: Format > Layer

Command line > LAYER

- Choose Format > Layer
- Click the icon under "On" tab in the layer list.
- Click OK button.

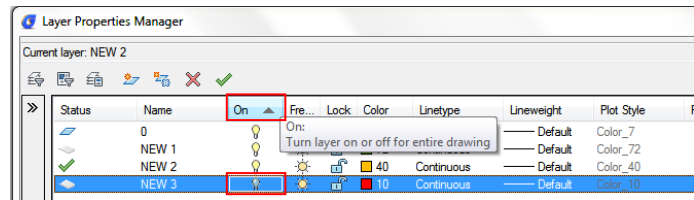

Locking and Unlocking Layers

Locking a layer prevents you from accidentally modifying its objects. When a layer is locked (but visible and thawed), you cannot edit them. If you lock the current layer, you can still add new objects to it. You can also change the linetype and color associated with a locked layer. Unlocking a layer restores full editing capabilities.

To lock or unlock layers: Format > Layer Command line > LAYER

- Choose Format > Layer from the main menu.
- Click the icon under "Lock" tab in the layer list.
- Click OK button.

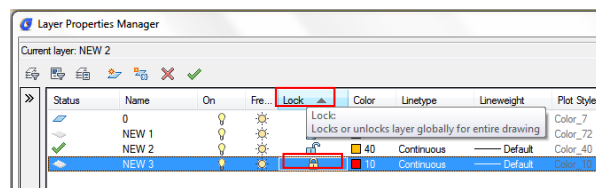

Controlling Layer Printing

Controlling layer printing is another way you can specify which objects print in your drawing. By controlling layer printing, you can turn off unnecessary information during printing. When you turn off printing for a layer, objects drawn on that layer are still visible, but they do not print.

To turn layer printing on or off: Format > Layer Command line > LAYER

- Choose Format > Layer
- Click the icon under "Plot" tab in the layer list.
- Click OK button.

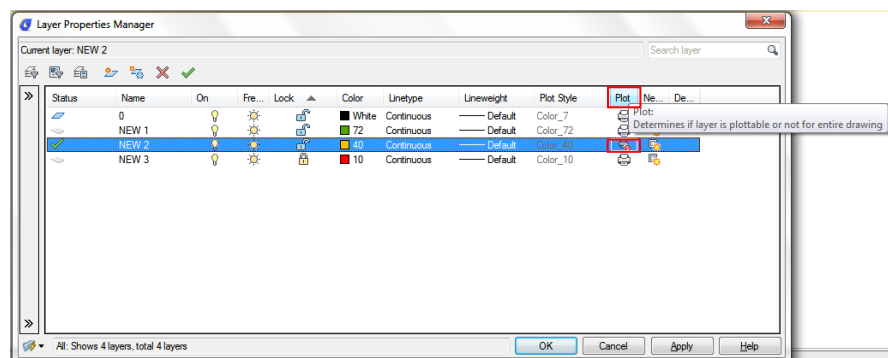

Setting a Layer's Print Style

If your drawing uses named print style tables, you can specify a print style for each layer. Named print style tables contain print styles that you set up to control what objects look like when they print, without actually changing the objects in the drawing. If your drawing uses color-dependent print style tables, you cannot specify a print style for a layer. These types of print style tables automatically determine printing requirements by the color assigned to a layer or an object.

To change the print style assigned to one or more layers (only in a drawing that uses named print style tables):

Format > Layer Command line> LAYER

- Choose Format > Layer
- Click the name of Plot Style in the layer list to open Select Plot Style dialog box, from which, you can specify the desired plot style.
- Click OK button.

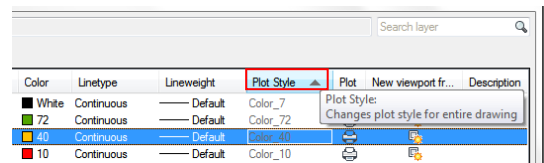

Freeze or Thaw Layers

You can also freeze layers to improve the performance of operations such as zooming and panning or producing hidden lines or shaded images. When a layer is frozen, objects drawn on that layer are no longer visible.

To freeze or thaw layers: Format > Layer Command line> LAYER

- Choose Format > Layer
- Click the icon under "Freeze" tab in the layer list.
- Click OK button.

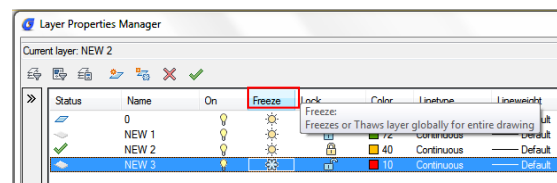

Setting the Layer Color

Each layer in a drawing is assigned a color. GstarCAD uses the BYLAYER color as the default color setting for object creation so that new objects are drawn in the color of the layer on which they are inserted.

To change the layer color:

Format > Layer Command line> LAYER

- Choose Format > Layer
- Click the icon under "Color" tab in the layer list to open Select Color dialog box, from which, you can specify the desired color through index, true and color books tabs
- Then click OK button.

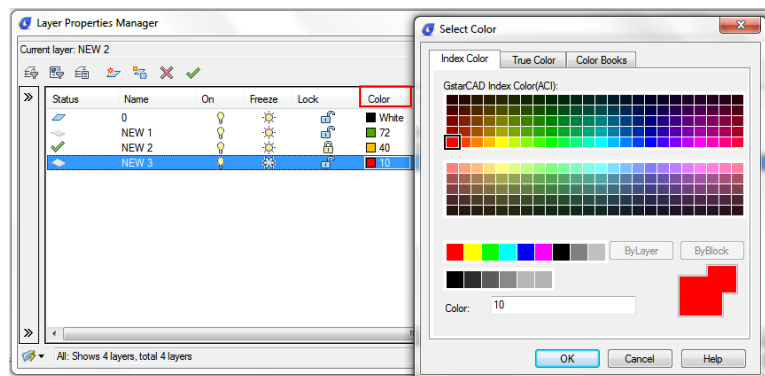

Setting a Layer's Linetype

Each layer uses a default linetype. Linetype determines the appearance of objects both on the screen and when printed. It's recommendable to assign the BYLAYER linetype to any objects that you draw on that layer.

To change the linetype assigned to one or more layers: Format > Layer Command line> LAYER

- Choose Format > Layer
- Click the Linetype name in the layer list to open Select Linetype dialog box, from which, you can specify the desired linetype.
- Click OK button.

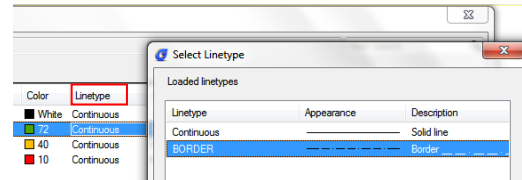

Setting a Layer's Lineweight

Each layer uses a default lineweight. Lineweights determine the thickness of objects both on the screen and when printed. All new layers are assigned the DEFAULT lineweight, which is .25 millimeters or .01 inches. If you want a different lineweight assigned to a layer, you can easily change it using Layer Properties Manager.

To change the lineweight assigned to one or more layers:
Format > Layer Command line> LAYER

- Choose Format > Layer
- Click the Lineweight name in the layer list to open Lineweight dialog box, from which, you can specify the desired lineweight.
- Click OK button.

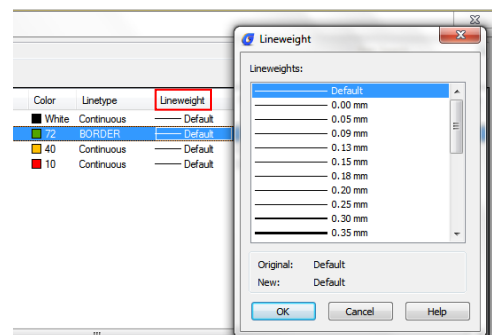

Filter List of Layers

You can use a layer filter to limit the display of layer names in the Layer Properties Manager. The following properties can be included in the filter definition: Layer names, colors, linetypes, lineweights, and plot styles. Whether layers are locked or unlocked, turned on or off, frozen or thawed in the current viewport or all viewports. When setting filter conditions, you can also use wild-card characters to filter names by name. For example, typing D* displays layer name preceded with D, just click Add button if the filter name has been specified.

To filter list of layers:

- Choose Format > Layer
- Click the New Property Filter icon, located at top left of the window.
- In the Layer Filter Properties dialog box, under filter definition, click the tabs properties you want to filter. Then click OK button.

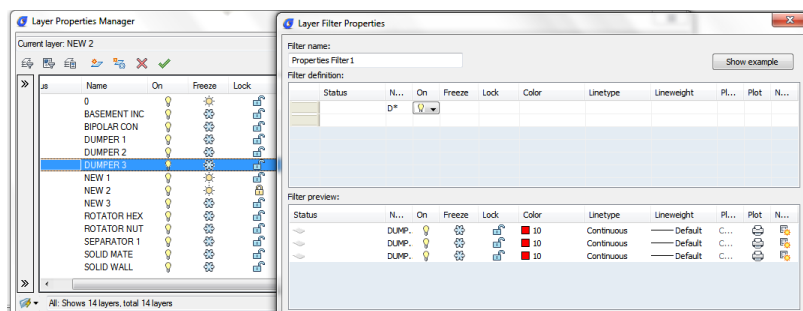

Displaying Lineweights

Lineweights are displayed differently in paper space layout than model space. Lineweights are useful for graphical representations of different objects and information.

Display Lineweights in Model Space

In model space, a 0-value lineweight is displayed as a pixel, and other lineweights are display with a pixel width proportional to their real-unit value. In model space, lineweight display does not change with the zoom factor. A lineweight value that is represented by a width of several pixels is always displayed using the same number of pixels. In model space, press LWT button on the status toolbar to turn lineweight display on and off.

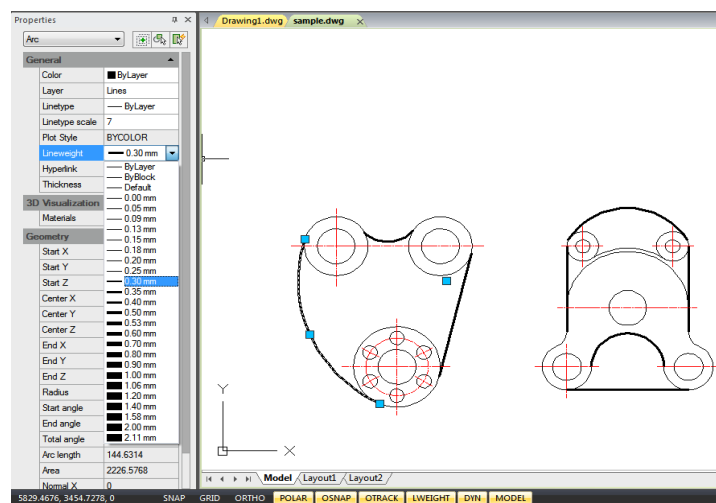

Display Lineweights in Layouts

In paper space (layout tab), lineweights are displayed in exact plotting width. In plot preview and paper space, lineweights are displayed in real-world units, and lineweight changes with the scale factor. From the Plotting Scale tab of Plot dialog box, you can control the lineweight plotting and scaling in a drawing. In paper space, press LWT button on the status toolbar to turn lineweight display on and off. This change does not affect the lineweight plotting.

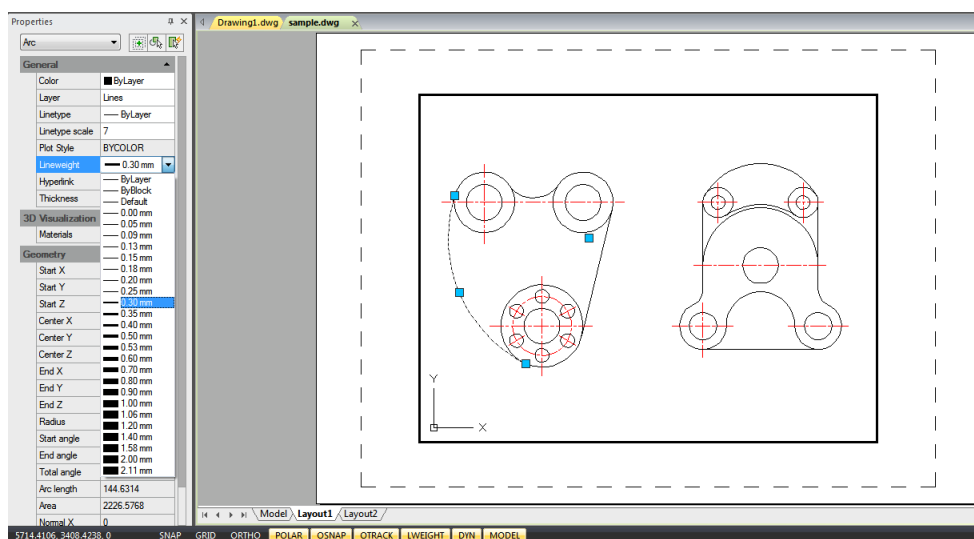

Create Objects

Drawings are made up of objects. In general, you draw objects by specifying points with the pointing device or by entering coordinate values at the command prompt.

Draw Linear Objects

Lines: A line consists of two points: a start point and an endpoint. You can connect a series of lines, but each line segment is considered a separate line object. **To draw a line:** Draw > Line Command line> LINE

- 1.Choose Draw > Line from the main menu.
- 2.Specify the start point.
- 3.Complete the first line segment by specifying the endpoint.
- 4.Press Enter to complete the command.

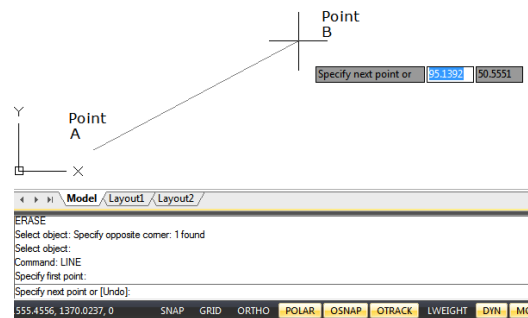

To start a new line at the endpoint of the last line drawn, start the Line command again and press Enter directly at the "Specify first point:" prompt.

Multilines: Multilines consist of several parallel lines, called elements.

You can determine the position of elements by specifying offset from the origin of each element. By default, multiline objects contain two elements. You can create and save new multiline styles by yourself or modify existing mline styles.

To draw a multi-line: Draw > Multiline Command line> MLINE

- 1.Choose Draw > Multiline from the main menu.
- 2.Specify the start point.
- 3.Specify the endpoint.
- 4.Press Enter to complete the command.

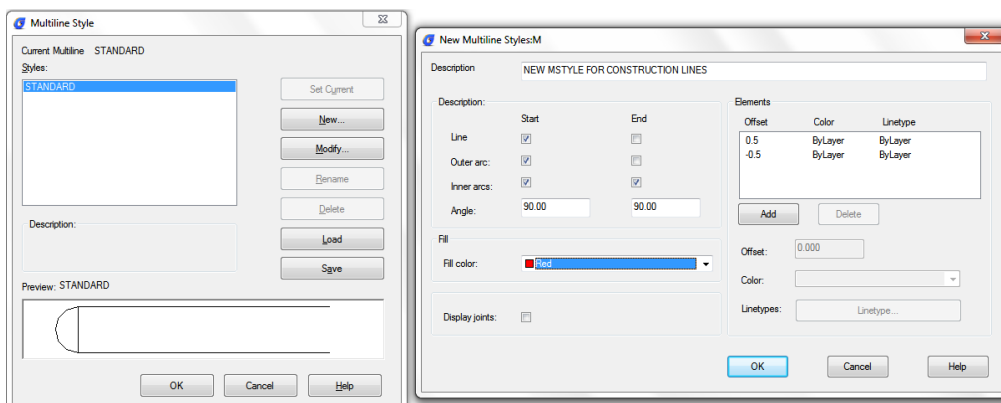
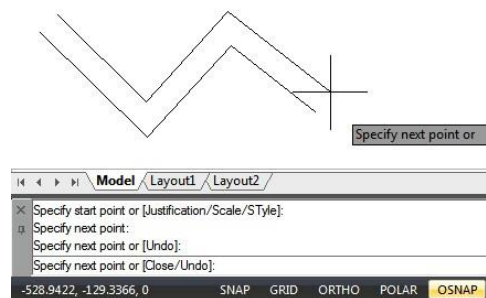

Rays: A ray is a line in three dimensional space that starts at a point and extends to infinity. Because rays extend to infinity, they are not calculated as part of the drawing extents. The default method for drawing a ray is to select the start point of the ray and then specify its direction. **To draw a ray:**

Draw > Ray Command line> RAY

- 1.Choose Draw > Ray from the main menu.
- 2.Specify the start point and the direction.
- 3.Press Enter to complete the command.

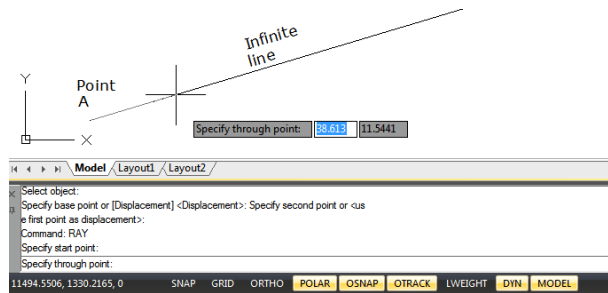

Construction Lines: A construction line is a line through a given point, oriented at a specified angle in three dimensional space and extending to infinity in both directions. You can also draw a construction line at a specific angle or at an angle relative to an existing object.

To draw a construction line:

Draw > Construction Line Command line> XLINE

- 1.Choose Draw > Construction Line from the main menu.
- 2.Specify a point along the line.
- 3.Specify the direction.
- 4.Press Enter to complete the command.

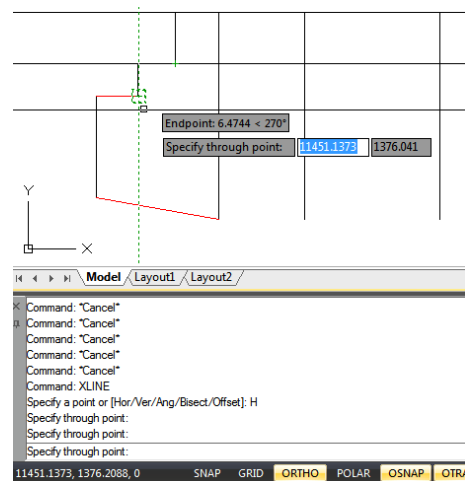

Polylines: A polyline is a single object with connected sequence of line segments or/and arc segments. When you draw a polyline, you can switch to different options. After you draw more than one segment, you can close the polyline, undo or finish.

To draw a polyline with straight segments:

Draw > Polyline Command line> PLINE

- 1.Choose Draw > Polyline from the main menu.
- 2.Specify the start point.
- 3.Specify the endpoint of each segment.
- 4.Press Enter to end, or enter c (close) to close the polyline.

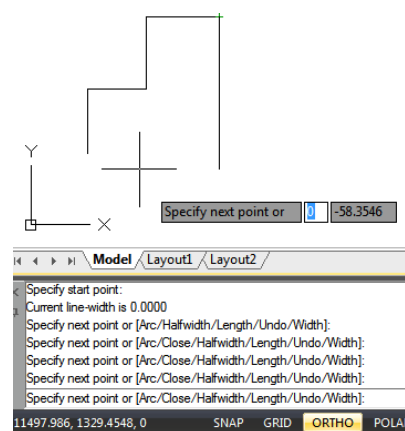

To draw a line and arc combination polyline:

Draw > Polyline Command line> PLINE

- 1.Choose Draw > Polyline from the main menu.
- 2.Specify the start point.
- 3.Specify the endpoint.
- 4.At the command prompt, choose Arc.
- 5.Specify the endpoint of the arc segment.
- 6.To complete the command, Press ENTER.

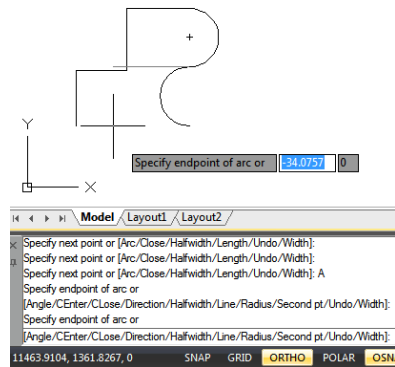

To create closed polylines: Draw > Polyline Command line> PLINE

When creating polylines with PLINE command, the Close option is only available if no less than two line or arc segments are drawn. A closed polyline object is drawn if you connect the start point of the polyline to endpoint of the last line or arc segment with a line or arc.

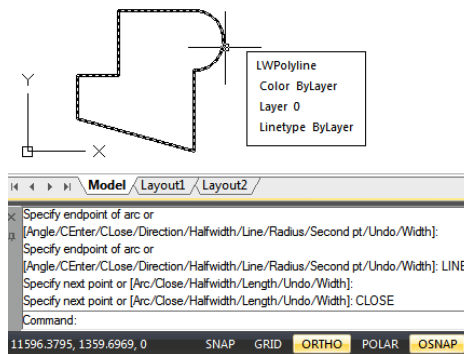

To create wide polylines: Draw > Polyline Command line> PLINE

You can draw polylines of various widths by using the Width and Halfwidth options of PLINE command. The Width and Halfwidth options set the width of the next polyline segments you draw. You can set the width of individual segments and make them taper gradually from one width to another.

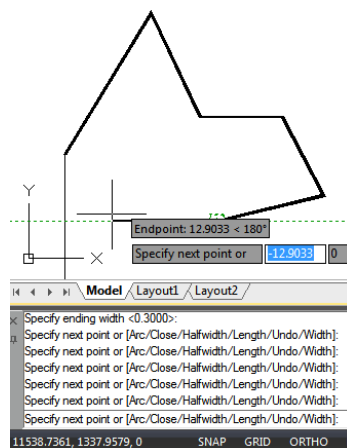

To draw a boundary polyline: Draw > Boundary Command line> BOUNDARY

- 1.Choose Draw > Boundary from the main menu.
- 2.Specify the objects by doing one of the following:

-**Current viewport** Define a boundary set with all entities in the current viewport. if this option is selected, any boundary set currently used will be canceled.

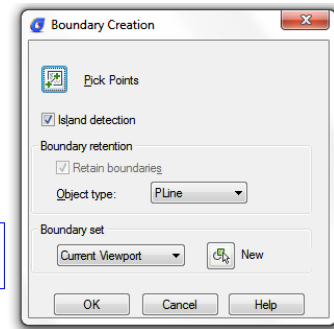
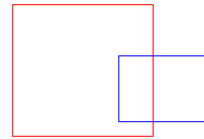

-Existing set Click **New** button to switch to the drawing area, and prompt users to select objects for defining boundary sets. Press

Enter to return to the dialog box after selection. This option is only available after selecting objects by using the New button.

- 3.Select the Island Detection option.
- 4.Click Pick Points.
- 5.In the drawing, click inside the area whose closed perimeter forms the boundary, not on the polyline itself. If desired, continue clicking inside additional closed perimeters.
- 6.To complete the selection, press Enter.
- 7.In the Boundary Creation dialog box, click OK.

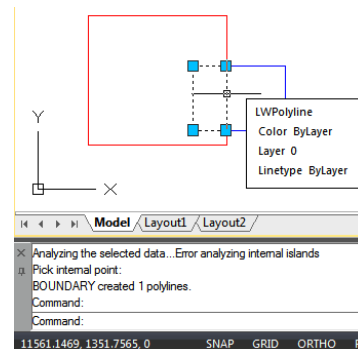
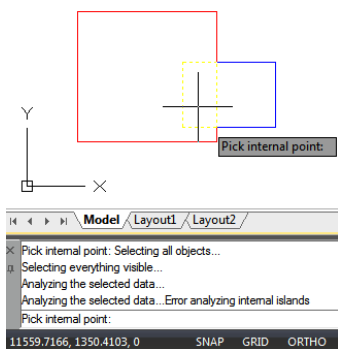

Polygons: Creating polygons is a simple way to draw squares, equilateral triangles, octagons, and so on. Polygons are closed polylines with between 3 and 1,024 equal-length sides.

To draw a polygon by vertex:

Draw > Polygon Command line>POLYGON

- 1.Choose Draw > Polygon from the main menu.
- 2.Type 6 to specify six sides for the polygon.
- 3.Specify the center of the polygon.
- 4.Specify the vertex of the polygon.

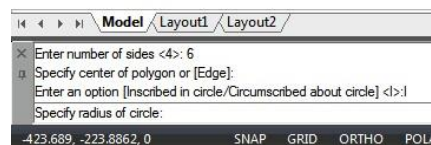
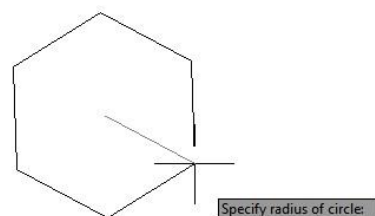

Rectangles: Rectangles are closed polylines with four sides. You draw a rectangle by specifying its opposite corners. The rectangle is normally aligned parallel to the current snap and grid alignment, but you can use the Rotated option to align the rectangle to any angle.

To draw a rectangle:

Draw > Rectangle Command line>RECTANG

1.Do one of the following:

- Select Draw > Rectangle on the main menu.
- Click the Rectangle tool or type RECTANG command and press Enter.

2. Identify one corner of the rectangle or enter an option. Specify first corner point or [Chamfer/Elevation/Fillet/Thickness/Width]:

3. Identify the opposite corner of the rectangle or enter an option. Specify other corner point or [Area/Dimensions/Rotation]:

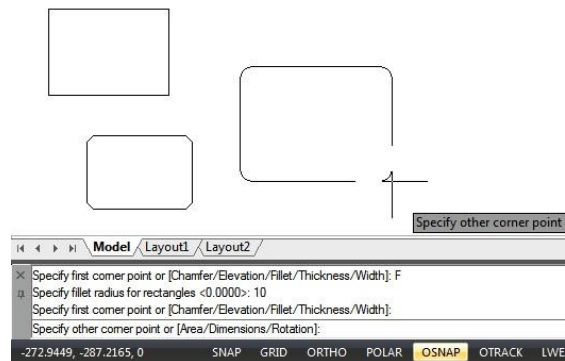

Points: You can draw a point object formatted as either a single dot or as one of 19 other possible display styles.

To draw a point: Draw > Point Command line>POINT

1. Choose Draw > Point > Single Point from the main menu.
2. Specify the location of the point.

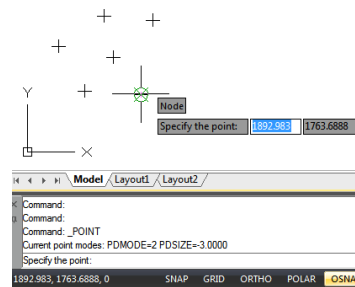

To draw several points:

1. Choose Draw > Point > Multiple Point from the main menu.
2. Specify the location of each point.

To change the size and appearance of point objects:

Format > Point Style Command line>DDPTYPE

1. Choose Format > Point Style from the main menu.
2. Under Point Style, select the style you want.
3. Under Point Size, specify the point size, or choose one of the options.
4. Click OK button.

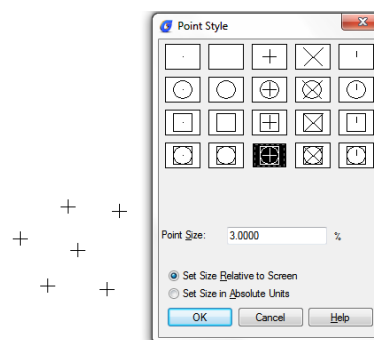

When you regenerate the drawing, all point objects change to reflect the new size and appearance settings.

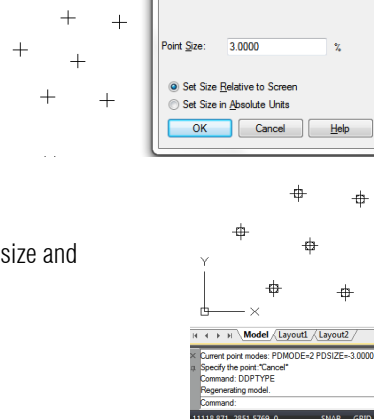

Freehand Sketches: A freehand sketch consists of many straight line segments, created either as individual line objects or as a polyline. Before you begin creating a freehand sketch, you must set the length, or increment, of each segment. The smaller the segments, the more accurate your sketch, but segments that are too small can greatly increase the file size.

To create a freehand sketch:

1. On the command line, enter SKETCH and press Enter.
2. At the "Record increment" prompt, enter the minimum line segment length.
3. Move the cursor to the drawing area, then click or enter p (pen) to begin sketching.
4. Click or enter p (pen) again to lift the pen up and stop drawing, so that you can move the cursor around the drawing area without drawing.
5. Enter R (Record) at any time to write into the drawing the line you're drawing and those already drawn.
6. Press Enter to complete the sketch and write all lines into the drawing.

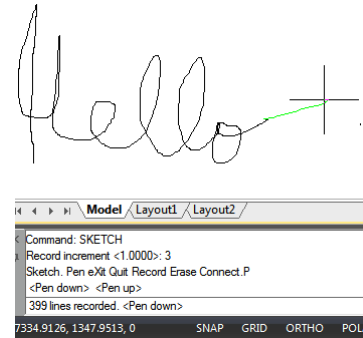

To erase freehand sketch lines:

1. While running the SKETCH command, enter E. If the pen was down, it moves up.
2. Move the cursor to the end of the line you drew last and then move it back as far along the line as you want to erase.
3. To end the erasure and return to the sketch Command prompt, enter E. If you want to change the current viewport while sketching, make sure the pen is up and all lines were written into the drawing.

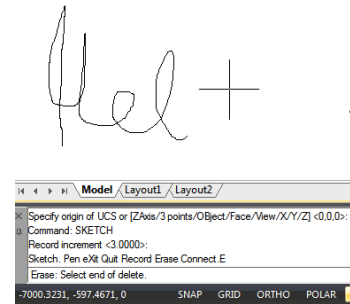

Draw Curved Objects

Arcs: An arc is a portion of a circle. There are numerous ways to define an arc, the default method uses three pick points, a start point, a second point and an end point. Using this method, the arc will start at the first pick point, pass through the second point and end at the third point. Once you have mastered the default method try some others:

- | | | |
|------------------------|---------------------|------------------------|
| -3 points | -Start, Center, End | -Start, Center, Angle |
| -Start, Center, Length | -Start, End, Angle | -Start, End, Direction |
| -Start, End, Radius | -Center, Start, End | -Center, Start, Angle |
| -Center, Start, Length | -Continue | |

To draw an arc by 3 points as sample:

Draw > Arc > 3 points

1. Choose Draw > Arc > 3 Points from the main menu.
2. Specify the start and second points.
3. Specify the endpoint.

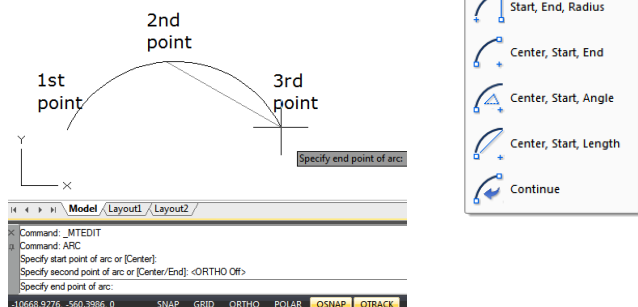

Circles: The default method for drawing a circle is to specify a center point and radius.

You can draw circles using any of following methods:

- Center, Radius -Center, Diameter
- 2 points -3 points
- Tangent, Tangent, Radius
- Tangent, Tangent, Tangent

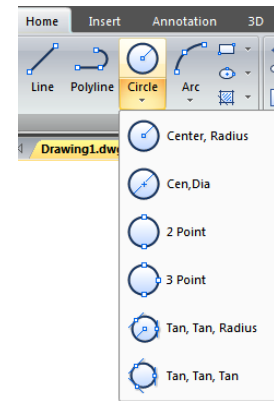

To draw a circle by specifying its center and radius:

Draw > Circle>Center, Radius Command line>CIRCLE

- 1.Choose Draw > Circle > Center, Radius from the main menu.
- 2.Specify the center point.
- 3.Specify the radius of the circle.

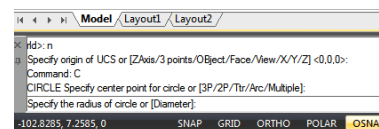
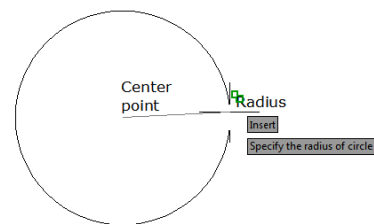

To draw a circle tangent to existing objects:

Draw > Circle>Tan, Tan, Radius Command line>CIRCLE

- 1.Choose Draw > Circle > Tan, Tan, Radius from the main menu.
- 2.Select the first tangent point on the object to be tangent with the circle.
- 3.Select the second tangent point on the object to be tangent with the circle.
- 4.Specify the radius of the circle.

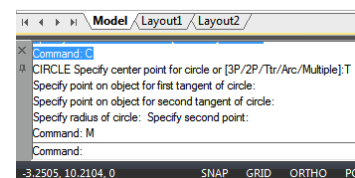
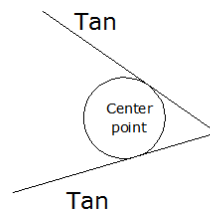

Ellipses: The default method for drawing an ellipse is to specify the endpoints of one axis of the ellipse, and then specify a distance representing half the length of the second axis. The endpoints of the first axis determine the orientation of the ellipse.

You can draw ellipses using any of the following methods: -Center -Axis, End -Ellipse, Arc

To draw an ellipse by specifying the axis and endpoints:

Draw > Ellipse>Axis Command line>ELLIPSE

- 1.Choose Draw > Ellipse > Axis, End from the main menu.
- 2.Specify the first endpoint and second endpoint.
- 3.Specify a distance for half the length of the second axis.

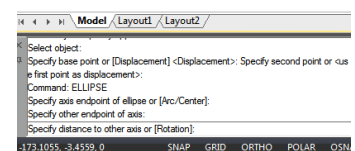
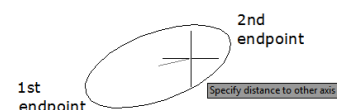

To draw an elliptical arc by specifying the axis endpoints:

Draw > Ellipse>Arc Command line>ELLIPSE

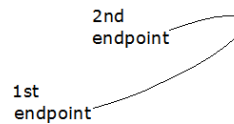

- 1.Choose Draw > Ellipse > Arc from the main menu.
- 2.Specify the first endpoint.
- 3.Specify the second endpoint.
- 4.Specify the half length of the other axis.
- 5.Specify the start angle of the arc.
- 6.Specify the end angle.

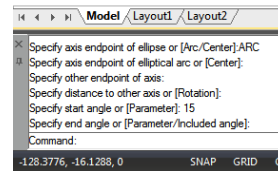

Splines: Spline is a smooth curve that passes through a series of control points. Multiple points are required for drawing irregular splines than can be closed as well, so the start and endpoints are coincident and tangent. The tolerance in a spline, describes how precisely fits between multiple points (lower tolerance, more closely the spline fits the points). Usually there are two ways to create splines:

- Create a spline converted from a polyline using Spline option of PEDIT command.
- Create a spline using SPLINE command.

To draw a spline: Draw > Spline Command line>SPLINE

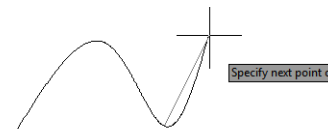

- 1.Choose Draw > Spline from the main menu.
- 2.Specify the first point of the spline.
- 3.Specify the second point of the spline.
- 4.Specify as many more points as you want.
- 5.When you have finished, press Enter.

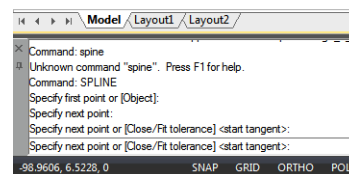

To draw a closed spline: Draw > Spline Command line>SPLINE

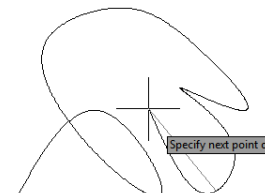

- 1.Choose Draw > Spline from the main menu.
- 2.Specify the first point of the spline.
- 3.Specify the second point of the spline.
- 4.Specify as many more points as you want.
- 5.When you have finished, on the command line, type C and press Enter.
- 6.To complete the command, specify the tangent point.

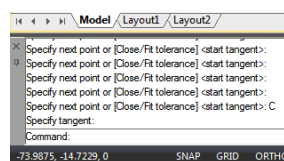
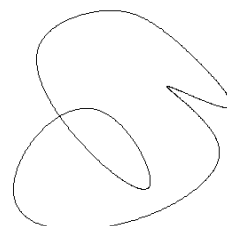
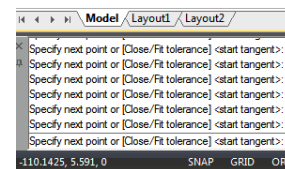

Helix: Creates a 2D spiral or 3D spring. Initially, the default base radius is set to 1. During a drawing session, the default value for the base radius is always the previously entered base radius value for any solid primitive or helix. The base radius and top radius cannot both be set to 0.

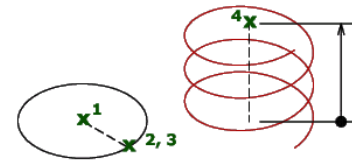

To draw a helix: Draw > Helix Command line>HELIX

The following prompts are displayed: Number of turns = 3 (default) Twist = CCW (default)

- 1.Specify center point of base: Specify a point
- 2.Specify base radius or [Diameter] <1.0000>: Specify a base radius, enter d to specify the diameter, or press ENTER to specify the default base radius value
- 3.Specify top radius or [Diameter] <1.0000>: Specify a top radius, enter d to specify the diameter, or press ENTER to specify the default top radius value
- 4.Specify helix height or [Axis endpoint/Turns/turn Height/tWist] <1.0000>: Specify a helix height, or enter an option

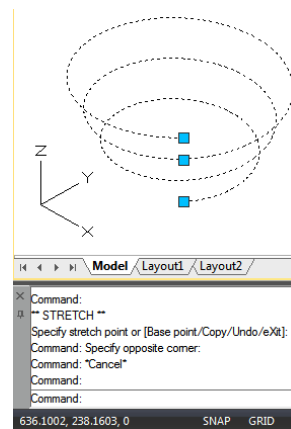
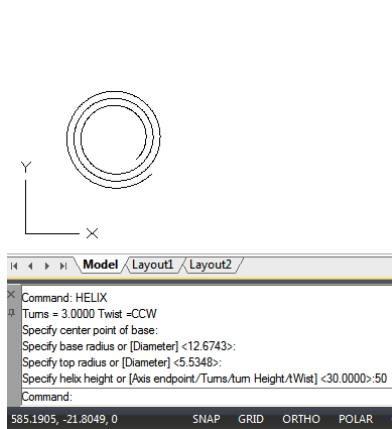

Donut: Donuts are solid, filled circles or rings created as closed, wide polyline. The system variable FILLMODE controls whether to fill the donut or not. FILLMODE is set to 1, creates filled donuts; if FILLMODE is set to 0, creates without filled.

To create a donut, you specify its inside and outside diameters and its center. You can continue creating multiple copies with the same diameter by specifying different center points. To create solid-filled circles, just assign the same value for the inside radius and outside radius.

To draw a donut: Draw > Donut Command line>DONUT

- 1.Choose Draw > Donut from the main menu.
- 2.Specify the inside diameter of the donut.
- 3.Specify the outside diameter of the donut.
- 4.Specify the center of the donut.
- 5.Specify the center point to draw another donut, or press Enter to complete the command.

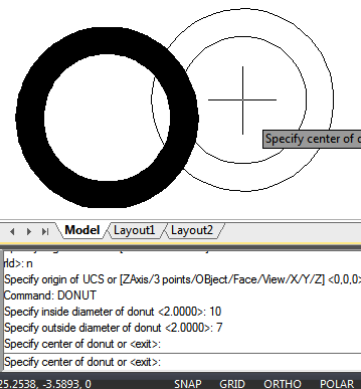

Create 3D Objects

With 3D models, you can: View entities in three dimensions, create three-dimensional entities, edit entities in three-dimensional space, edit three-dimensional solids, display hidden-line and shaded views of three-dimensional entities.

3D Thickness and Elevation: By default, the program creates new two dimensional objects with a zero elevation and thickness. The easiest way to create a three dimensional object is to change the elevation or thickness property of an existing two dimensional object. You can extrude any two dimensional object into a three dimensional object by changing the thickness of the object to a nonzero value. For example, a circle becomes a cylinder, a line becomes a three dimensional plane, and a rectangle becomes a box.

To set the current elevation: Command line>CHANGE

- 1.Type CHANGE on the command line, and then press Enter after selecting the two dimensional object(s).
- 2.Enter P (Properties) and press Enter.
- 3.Enter E (Elev) and press Enter.
- 4.Specify a new elevation, and then press Enter.

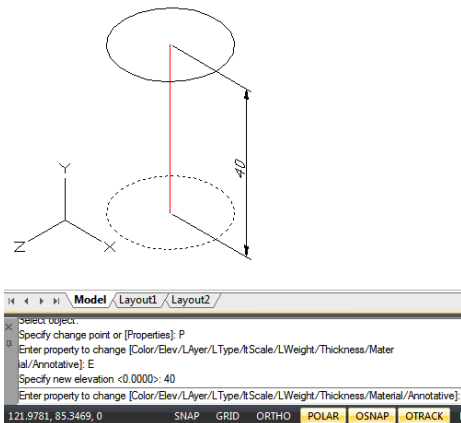

To set the current thickness:

Command line>CHANGE

- 1.Type CHANGE on the command line, and then press Enter after selecting the two dimensional object(s).
- 2.Enter P (Properties) and press Enter.
- 3.Enter T (Thickness) and press Enter.
- 4.Specify a new Thickness, and then press Enter.

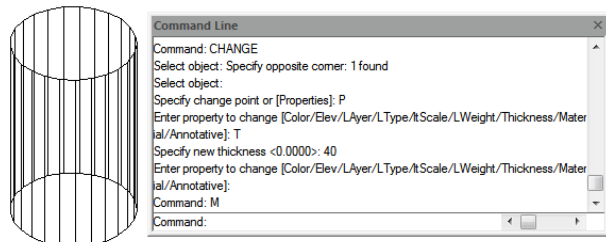

3D Faces: You can create a three dimensional face, which consists of a section of a plane in three dimensional space. After you specify the fourth point, the program continues to prompt you for additional faces by alternating prompts for the third point and fourth point to allow you to build a complex three dimensional object.

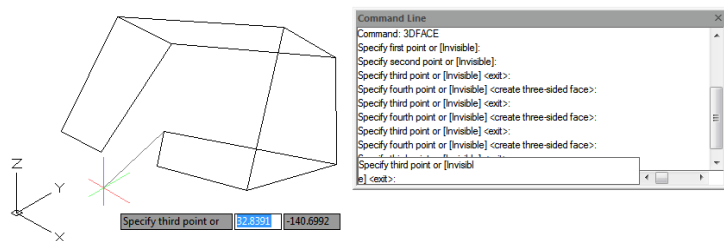

To create a three dimensional face: Draw > Modeling>Meshes> 3D Face Command line>3DFACE

- 1.Type 3Dface on the command line.
- 2.Specify the first point of the three-dimensional face.
- 3.Specify the second, third, and fourth points.
- 4.Specify the third and fourth points for additional faces.
- 5.To complete the command, press Enter.

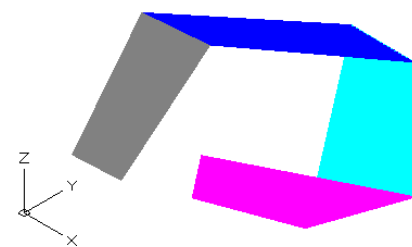

Ruled Surfaces: You can create a ruled surface, which is a three-dimensional body that approximates the surface between two existing entities. You select the two entities that define the ruled surface. These entities can be arcs, circles, lines, points, or polylines.

To create a ruled surface:

Draw > Modeling>Meshes>Ruled Mesh Command line>RULESURF

- 1.Type RULESURF on the command line.
- 2.Select the first defining object.
- 3.Select the second defining object.

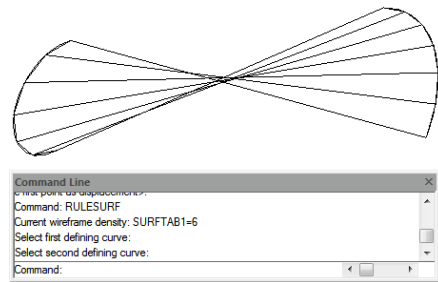

Tabulated Surface: Tabulated surface meshes are used as a serial of paralleled polygon on specified path, you should draw direction vector and original object before creating a tabulated surface. The objects like a line, arc, circle, ellipse, or 2D or 3D polyline can be used as outline curves for defining polygons.

To create an extruded surface mesh:

Draw > Modeling>Meshes>Tabulated Mesh Command line>TABSURF

- 1.Type TABSURF on the command line.
- 2.Select the object to extrude.
- 3.Select the extrusion path.

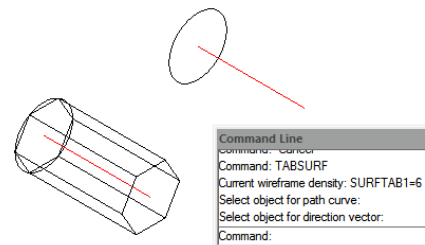

Revolved Surface: Use REVSURF command to create a surface of revolution by rotating a profile of the object about an axis. The object to be revolved can be a line, arc, circle, ellipse, elliptical arc, closed polyline, polygon, closed spline or torus. REVSURF is useful for surfaces with rotational symmetry.

To create a revolved surface mesh: Draw > Modeling>Meshes>Revolved Mesh Command line>REVSURF

- 1.Type REVSURF on the command line.
- 2.Select the object to revolve.
- 3.Select the object to be used as the axis of revolution.
- 4.Specify the starting angle.
- 5.Specify the number of degrees to revolve the object.

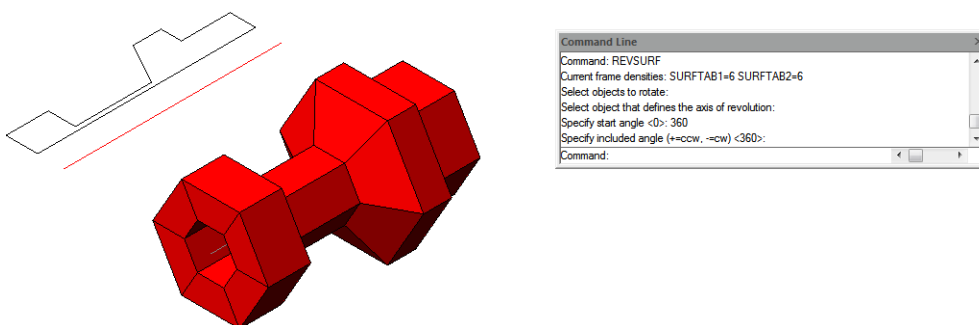

Solid Box: A solid box consists of six rectangular surface planes. The base of the box is always parallel with the xy plane of the current UCS. The length of the box is mapping to X axis of current UCS, and its width maps to Y axis, and height maps to Z axis. RECTANG or PLINE command creates a rectangle or closed polyline from which you can create a box using EXTRUDE.

To create a box:

Draw > Modeling>Box Command line>BOX

- 1.Choose Draw > Modeling > Box from the main menu.
- 2.Specify the first corner of the base.
- 3.Specify the opposite corner of the base.
- 4.Specify the height.

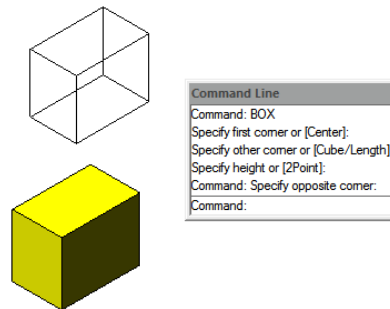

Solid Cone: By default, the cone's bottom lies on the XY plane of the current UCS. The cone height is parallel to the Z axis. The apex determines the height and orientation of the cone. You can draw a 2D circle and then use EXTRUDE to taper the circle at an angle along the Z axis to create a solid cone. To complete the truncation, you can subtract a box from the tip of the cone with the SUBTRACT command.

To create a cone:

Draw > Modeling>Cone Command line>CONE

- 1.Choose Draw > Modeling > Cone from the main menu.
- 2.Specify the center of the base of the cone.
- 3.Specify the radius or diameter.
- 4.Specify the height.

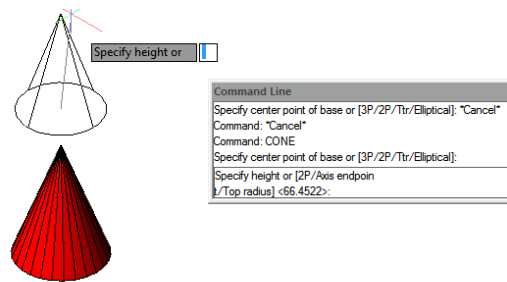

Solid Cylinder: You can create cylinders defined by a circular base. The base of a cylinder is always parallel with the xy plane of the current UCS; the height of a cylinder is always parallel with the z axis. You can draw a circle and then use EXTRUDE to create a solid cylinder.

To create a cylinder:

Draw > Modeling>Cylinder Command line>CYLINDER

- 1.Choose Draw > Modeling > Cylinder from the main menu.
- 2.Specify the center of the base of the cylinder.
- 3.Specify the radius or diameter.
- 4.Specify the height.

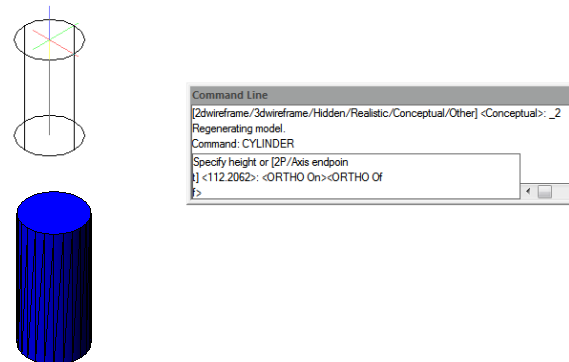

Sphere: The latitude lines of a sphere are always parallel with the xy plane of the current UCS; the central axis is always parallel with the z axis. You determine the size of a sphere by specifying either its radius or its diameter.

To create a sphere: Draw > Modeling>Sphere Command line>SPHERE

- 1.Choose Draw > Modeling > Sphere from the main menu.
- 2.Specify the center of the sphere.
- 3.Specify the radius or diameter.

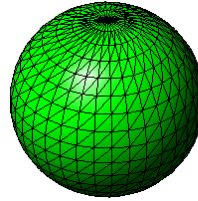

```
Command Line
Select object: Specify opposite corner: 2 found
Select object:
Command: SPHERE
Specify center point or [3P/2P/Tr]:
Specify radius or[Diameter]:
Command:
```

Torus: A torus is constructed by revolving a circle about a line drawn in the plane of the circle and parallel with the z axis of the current UCS. You determine the size of a torus by specifying its overall diameter or radius and the diameter or radius of the tube (the circle being revolved).

To create a torus: Draw > Modeling>Torus Command line>TORUS

- 1.Choose Draw > Modeling > Torus from the main menu.
- 2.Specify the center of the whole torus.
- 3.Specify the radius or diameter of the whole torus.
- 4.Specify the radius or diameter of the body of the torus.

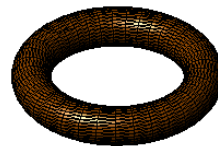

```
Command Line
Select object:
Command: TORUS
Specify center point or [3P/2P/Tr]:
Specify radius or[Diameter]:
Specify tube radius or [2Point/Diameter]:
Command:
```

Pyramid: You can create a tetrahedron (three-sided pyramid) or a four-sided pyramid. The base of the pyramid is always parallel to the xy plane of the current UCS. You determine the size of the pyramid by specifying the base points and either the apex, the corners of the top surface, or the endpoints of the ridge.

To create a pyramid: Draw > Modeling>Pyramid Command line>PYRAMID

1. Choose Draw > Modeling > Pyramid from the main menu.
2. Specify the first point for the base of the pyramid.
3. Specify the second and third points.
4. In the prompt box, choose Tetrahedron.
5. Specify the apex of the tetrahedron.

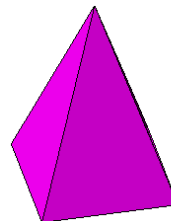

```
Command Line
Command: PYRAMID
4 sides Inscribed Circumscribed
Specify center point of base or [Edge/Sides]:
Specify base radius or [Inscribed] <32.9466>:
Specify height or [2P/Axis endpoint/Top radius] <141.6194>:
Command:
```

Wedge: You can create three dimensional wedges consisting of five surface planes. You determine the size of the wedge by either specifying a second corner and the height; defining the wedge based on a cube having a given length; or specifying the length, width, and height.

To create a wedge: Draw > Modeling>Wedge Command line>WEDGE

- 1.Choose Draw > Modeling > Wedge from the main menu.
- 2.Specify the first corner of the base.
- 3.Specify the opposite corner of the base.
- 4.Specify the height.

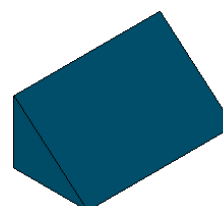

```
Command Line
Specify height or [2Point] <55.1953>: "Cancel"
Command: WEDGE
Specify first corner or [Center]:
Specify other corner or [Cube/Length]:
Specify height or [2Point] <55.1953>:
Command:
```

Solids Extrude: EXTRUDE command, extrudes the profiles of the selected object along the chosen path to create solids. The entities you can extrude are planar 3D faces, closed polylines, polygons, circles, ellipses, closed splines, donuts, and regions. You cannot extrude objects contained within a block or polylines that have crossing or self-intersecting segments.

To create an extruded solid:

Draw > Modeling>Extrude Command line>EXTRUDE

- 1.Choose Draw > Modeling > Extrude from the main menu.
- 2.Select the object to extrude.
- 3.Select the extrusion path, or specify the height.

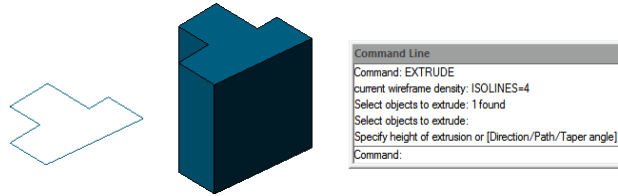

Solids Revolve: REVOLVE command revolves a 2D object to the specified certain angle to form solids. The revolving axis can be X, Y axis of current UCS as well as lines, polylines. Objects can be revolved are closed polylines, polygons, rectangles, circles, ellipses, regions and so on.

To create a revolved solid: Draw > Modeling>Revolve Command line>REVOLVE

- 1.Choose Draw > Modeling > Revolve from the main menu.
- 2.Select the object to revolve.
- 3.Do one of the following to define the axis of revolution:
 - Specify a start point and an end point.
 - Type o and press Enter to select an object.
 - Type x and press Enter to select the x axis.
 - Type y and press Enter to select the y axis.
- 4.Specify the angle of revolution.

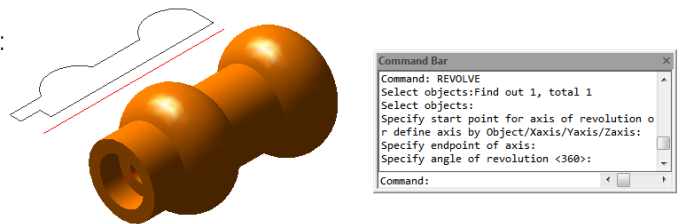

Creating Composite Solids: You can create composite three-dimensional solids by combining, subtracting, and finding the intersection of two or more solids. With UNION command, you can combine the total volume of two or more solids or two or more regions into a composite object.

To combine solids:

Modify> Solid Editing>Union Command line>UNION

- 1.Choose Modify>Solid Editing> Union from the main menu.
- 2.Select the objects to combine.

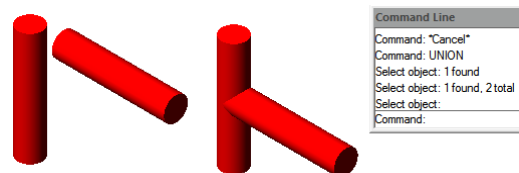

To subtract solids:

Modify>Solid Editing>Subtract Command line>SUBTRACT

- 1.Choose Modify>Solid Editing>Subtract from the main menu.
- 2.Select the objects to subtract from one another.

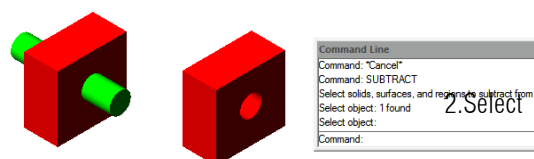

To intersect solids: Modify > Solid Editing > Intersect Command line > INTERSECT

1. Choose Modify > Solids Editing > Intersect from the main menu.
2. Select the objects to intersect.

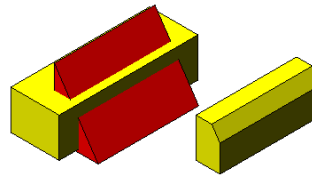

```
Command Line
Command: "Cancel"
Command: "Cancel"
Command: INTERSECT
Select object: Specify opposite corner: 2 found
Select object:
Command:
```

Create Regions: You can convert a closed object into a two dimensional region. After you create a region, you can modify it using the various three dimensional tools. You can create regions from closed objects, such as polylines, polygons, circles, ellipses, closed splines, and donuts.

To create a region: Draw > Region Command line > REGION

1. Choose Draw > Region from the main menu.
2. Select the objects to create the region and press Enter.

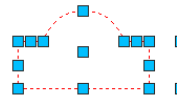

```
Command Line
Command: REGION
Select object: Specify opposite corner: 6 found
Select object:
1 loop extracted.
Created 1 region.
Command:
Region
Color Red
Layer 0
Linetype ByLayer
```

Create Revision Cloud: REVCLLOUD command, creates a polyline of sequential arcs to form a cloud-shaped object. You can convert objects, such as a circle, ellipse, polyline, or spline, to a revision cloud. You can set the minimum and maximum default values for the arc lengths of a revision cloud.

To create a revision cloud: Command line > REVCLLOUD

1. After type REVCLLOUD command, specify the first point.
2. Guide crosshairs along cloud path.
3. Revision cloud finished (the device point is near to first point).

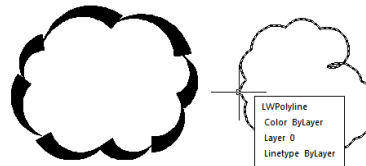

```
Command Line
Command: REVCLLOUD
Minimum arc length: Maximum arc length: Style: Normal
Specify start point or [Arc length/Object/Style] <Object>:
Guide crosshairs along cloud path...
Revision cloud finished.
Command:
```

Create Break Line: Creates a polyline and inserts the breakline symbol. To use your own block for the breakline symbol, make sure that the block contains two point objects on the Defpoints layer.

To create a revision cloud: Command line > BREAKLINE

1. Type BREAKLINE on the command line.
2. Specify first and second point for breakline.
3. Specify location for break symbol.

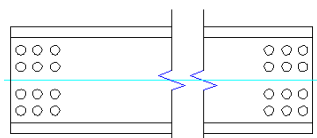

```
Command Line
Block = BRKLINE.DWG, Size = 1.00, Extension = 2.50
Specify first point for breakline or [Block/Size/Extension/sSpecify line for breakline]:
Specify second point for breakline:
Specify location for break symbol <Midpoint>:
Command:
```

Create Wipeout: Wipeouts are created using existing polygons, closed zero-width polylines made up of only line segments, or new polylines that you draw while using the WIPEOUT command.

To draw a wipeout: Draw > Wipeout Command line > WIPEOUT

1. Choose Draw > Wipeout from the main menu.
2. Specify the start point and endpoint of each segment.
3. After specifying the last endpoint, press Enter.

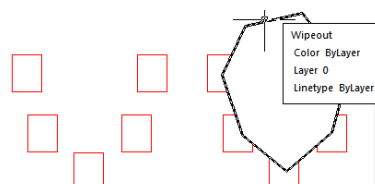

```
Command Line
Command: WIPEOUT
Specify first point or [Frames/Polyline] <Polyline>:
Specify next point:
Specify next point or [Undo]:
Specify next point or [Close/Undo]:
Specify next point or [Close/Undo]:
Command:
```

Modify Objects

You can easily modify the size, shape, and location of objects. You can either, enter a command first and then select the objects to modify, or you can select the objects first and then enter a command to modify them.

Remove Objects: You can use ERASE command to delete objects, whatever the methods you use to select objects. To restore the deleted objects, use UNDO command. You can remove objects using one of the following methods: Delete objects with ERASE command, cut the selected objects to the clipboard, or press DELETE to remove the selected objects.

Copy Objects: You can duplicate objects within the current drawing. The default method is to create a selection set and then specify a base point, and a displacement point, for the copy. To copy objects at the specified distance, you can specify the distance directly when the Ortho Mode or Polar Tracking is on.

Create only one copy of object one time:

1. Choose Modify > Copy from the main menu.
2. Select the objects, and then press Enter.
3. On the command line, type O (mOde).
4. On the command line, type S (Single).
5. Specify the base and displacement point.

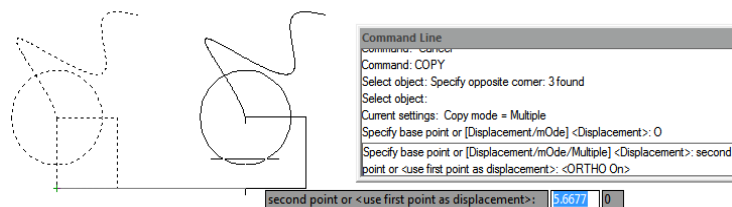

Create multiple copies for selected object one time:

1. Choose Modify > Copy from the main menu.
2. Select the objects, and then press Enter.
3. On the command line, type O (mOde).
4. On the command line, type M (Multiple).
5. Specify the base and displacement point of the first copy.
6. Specify the displacement point of the next copy.
7. To complete the command, press Enter.

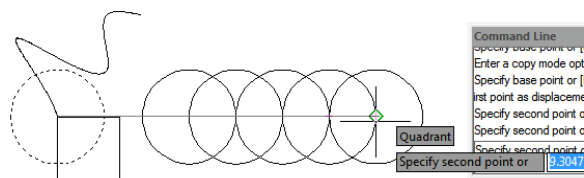

Mirror Objects: You can specify a baseline to create a mirror image using MIRROR command. The mirror image is symmetrical with the original one. So if you want to create a symmetrical objects, you only need to draw a half one, then create a full one using MIRROR command.

To mirror objects:

1. Choose Modify > Mirror from the main menu.
2. Select the object, and then press Enter.
3. Specify the first and second point of the mirror line.
4. On the command line, if you want to retain the original objects, type N; if you want to delete the original objects, type Y.

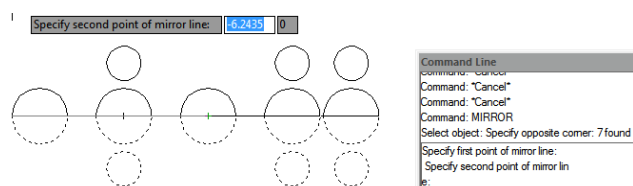

Offset an Object: You can use the offset to copy selected objects and align them offset to the original objects at a specified distance. You can make offset objects using arcs, circles, ellipses, elliptical arcs, lines, two dimensional polylines, rays, and infinite lines.

To make an offset copy by specifying the distance:

1. Choose Modify > Offset from the main menu.
2. Specify the distance (select two points or enter a distance).
3. Select the object to offset.
4. Specify on which side of the object to place the parallel copy.
5. Press Enter to complete the command.

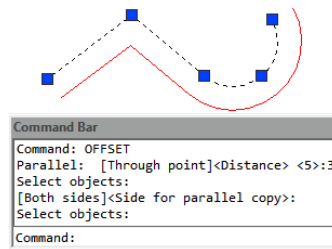

To make an offset copy passing through a point:

1. Choose Modify > Offset from the main menu.
2. On the command line, type T (Through).
3. Select the object to offset.
4. Specify the point for the object to pass through.
5. Press Enter to complete the command.

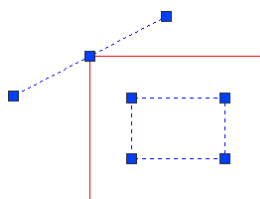

Create an Array of Objects: You can create copies of objects that array in rectangular or polar pattern. For rectangular arrays, you can specify the number of rows and columns as well as the interval; for polar arrays, you can specify the number of copies of the objects and determine whether the copies are rotated.

To create a rectangular array:

1. Choose Modify > Array from the main menu.
2. In the Array dialog box, click Rectangular Array.
3. Click the Select Objects button, and then select objects to array in your drawing.
4. In the Array dialog box, specify the row and column offset distance and angle of offset.
5. Click OK.

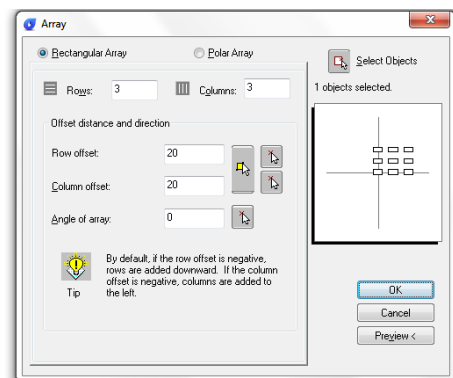
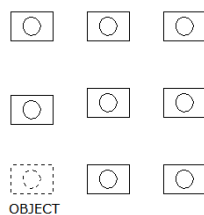

To create a polar array:

1. Choose Modify > Array from the main menu.
2. In the Array tab, click Polar Array.
3. Click the Select Objects button, and then select objects to array in your drawing.

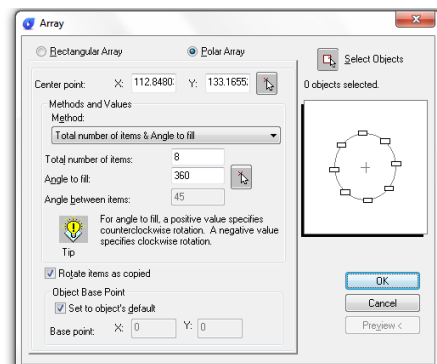
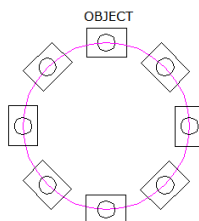

4. In the Array dialog box, choose Method and values you desired and click OK.

Move Objects: You can move objects to a new place without changing the objects. You can perform MOVE command and then select object (1) to move; specify a base point (2) and Displacement point (3). The object is moved from point 2 to the point 3.

To move entities:

1. Choose Modify > Move from the main menu.
2. Select the objects, and then press Enter.
3. Specify the base and displacement point.

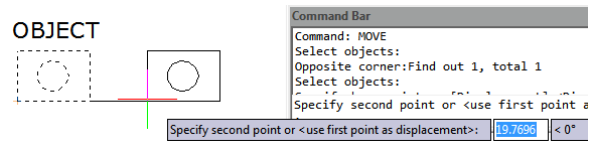

To move an object using grips:

1. Select the object.
2. Click a grip to select it.
3. Drag the object to where you want to relocate it and press Click to release.

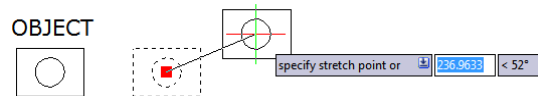

Rotate Objects: You can rotate the selected objects around a specified point. You can specify the rotated angle by specifying a point on the drawing or entering the angle value directly. The direction that objects rotate depends on the value you enter is positive or negative.

To rotate objects:

1. Choose Modify > Rotate from the main menu.
2. Select the objects, and then press Enter.
3. Specify the base point and rotation angle.

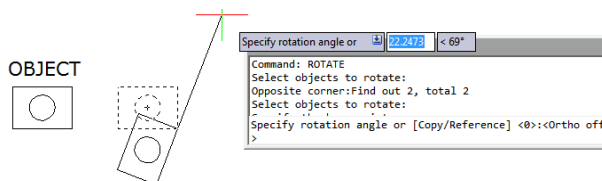

To rotate a selection set in reference to an Absolute Angle:

1. Choose Modify > Rotate from the main menu.
2. Select the objects, and then press Enter.
3. Specify the base point.
4. On the command line, type R (Reference).
5. Specify the reference and new angle.

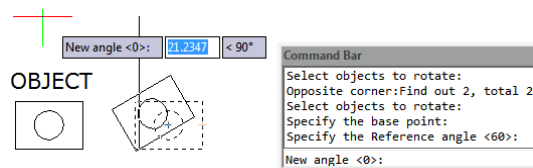

Align Objects: You can align objects with another through move or rotation with ALIGN command.

To align an object to another as reference:

1. Choose Modify > Align from the main menu.
2. Select the object, and then press Enter.
3. Specify the first source point.
4. Specify the destination point.
5. Press Enter to finish the command.

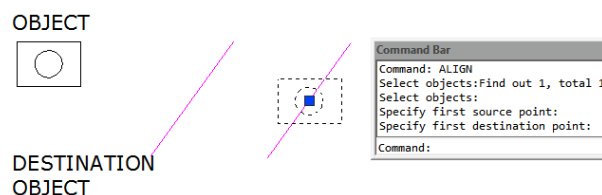

Scale Objects: You can use SCALE command to scale the proportionality of the selected objects. You can type a scale factor or specify a base point and distance to zoom objects. A scale factor that is greater than 1 enlarges the object; and a scale factor that is smaller than 1 shrinks the object.

To scale a selection set by a scale factor:

1. Choose Modify > Scale from the main menu.
2. Select the objects, and then press Enter.
3. Specify the base point.
4. Specify the scale factor.

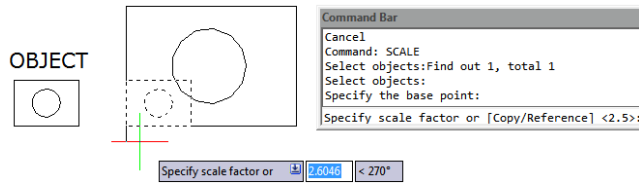

Lengthen Objects: You can change the length of entities or the included angle of arcs. The results are similar to extending and trimming. This command does not affect the closed entities.

To change the length of an object by dragging:

1. On the command line type LENGTHEN.
2. On the command line, type DY (DYnamic).
3. Select the object you want to change.
4. Specify the new endpoint or included angle.

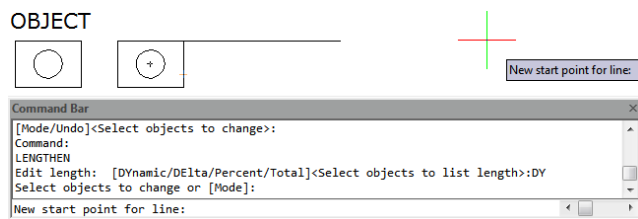

Stretch Objects: When stretching objects, you have to specify a base point and displacement point. You should use crossing selection to select the desired objects. With using grip edition, you can also stretch objects.

To stretch an object:

1. Choose Modify > Stretch from the main menu.
2. Select the objects using either a crossing window or a crossing polygon, and then press Enter.
3. Specify the base point.
4. Specify the second point of displacement.

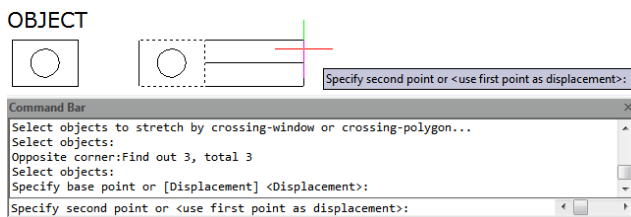

To stretch an object using grips:

1. Select the object.
2. Click a grip to activate it.
3. Drag the grip.
4. Click to release.

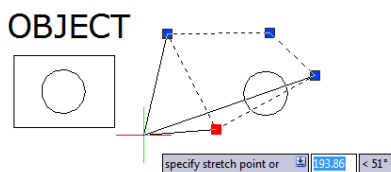

Trim Objects: You can clip, or trim, objects so they end at one or more implied cutting edges defined by other objects. You can trim arcs, circles, lines, unclosed polylines, and rays.

To trim an object:

1. Choose Modify > Trim from the main menu.
2. Select one or more cutting edges, and then press Enter.
3. Select the object to trim.
4. Press Enter to complete the command.

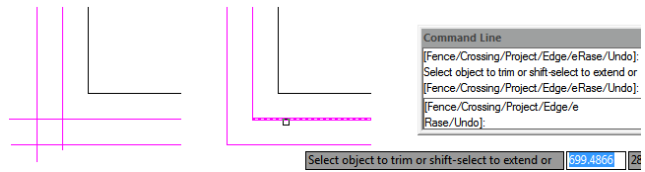

To trim several objects using the fence selection method:

1. Choose Modify > Trim from the main menu.
2. Select one or more cutting edges, and then press Enter.
3. On the command line, type F (Fence).
4. Specify the first point of the fence.
5. Specify the second point of the fence.
6. Press Enter to complete the command.

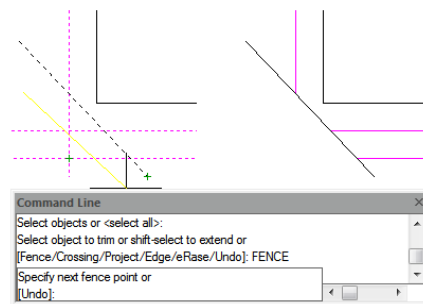

Extend Objects: You can extend objects so that they end at a boundary defined by other objects. You can extend arcs, lines, two-dimensional polylines, and rays. Arcs, circles, ellipses, lines, splines, polylines, rays, infinite lines, and viewports on a Layout tab can act as boundary edges.

To extend an object:

1. Choose Modify > Extend from the main menu.
2. Select one or more objects as boundary edges, and then press Enter.
3. Select the object to extend, and press Enter to finish the command.

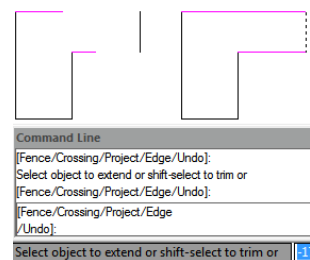

To extend an object to an implied boundary:

1. Choose Modify > Extend from the main menu.
2. Select one or more boundary edges, and then press Enter.
3. On the command line, type E (Edge).
4. On the command line, type E (Extend).
5. Select the object to extend, and press Enter to finish.

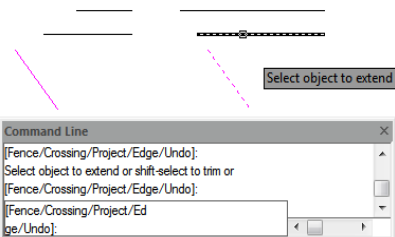

To extend several objects using the fence selection method:

1. Choose Modify > Extend from the main menu.
2. Select one or more boundary edges, and then press Enter.
3. On the command line, type F (Fence).
4. Specify the first and second point of the fence.
5. Press Enter to complete the command.

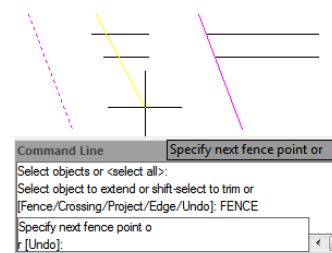

Create Breaks: You can break arcs, circles, ellipses, lines, polylines, rays, and infinite lines. When breaking entities, you must specify two points for the break. By default, the point you use to select the entity becomes the first break point; however, you can use the first break point option to select a break point different from the one that selects the entity.

To break an object:

1. Choose Modify > Break from the main menu.
2. Select the object.
3. Specify the second break point.

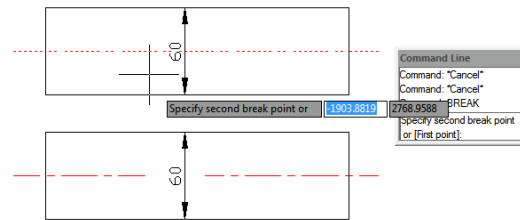

To select an object and then specify the two break points:

1. Choose Modify > Break from the main menu.
2. Select the object.
3. On the command line, type F (First point).
4. Specify the first and second break point.

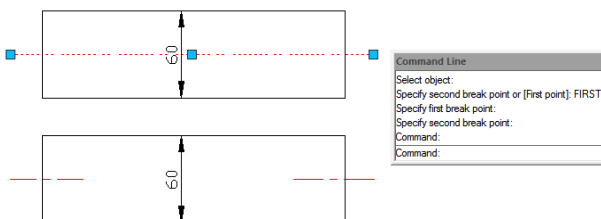

Create Chamfers: You can connect two nonparallel objects by extending or trimming them and then joining them with a line to create a beveled edge. You can chamfer lines, polylines, rays, and infinite lines. When creating a chamfer, you can specify how far to trim the objects back from their intersection (distance distance method), or you can specify the length of the chamfer and the angle it forms along the first object (distance angle method).

When chamfering a polyline, you can chamfer multiple segments between two selected polyline segments, or you can chamfer the entire polyline.

To chamfer two objects using the distance-distance method:

1. Choose Modify > Chamfer from the main menu.
2. On the command line, type D (Distance).
3. Specify the first chamfer distance.
4. Specify the second chamfer distance.
5. Select the first object to chamfer.
6. Select the second object to chamfer.

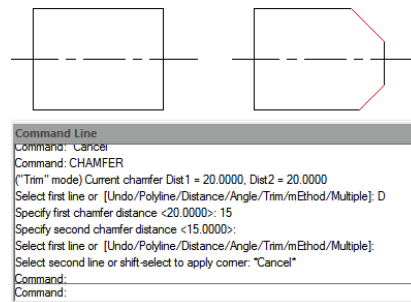

To chamfer two objects using the distance-angle method:

1. Choose Modify > Chamfer from the main menu.
2. On the command line, type A (Angle).
3. Specify chamfer length on the first line.
4. Specify chamfer angle from the first line.
5. Select the first object to chamfer.
6. Select the second object to chamfer.

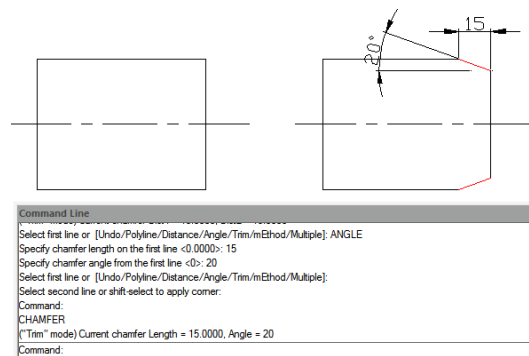

To chamfer selected vertices in a polyline:

- 1.Choose Modify > Chamfer from the main menu.
- 2.Select one polyline segment where you want to begin the chamfer.
- 3.Select the other polyline segment where you want to end the chamfer.

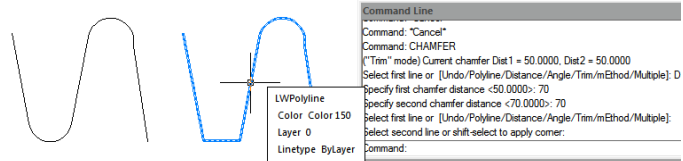

To chamfer all vertices in a polyline:

- 1.Choose Modify > Chamfer from the main menu.
- 2.On the command line, type P (Polyline).
- 3.Select the polyline.

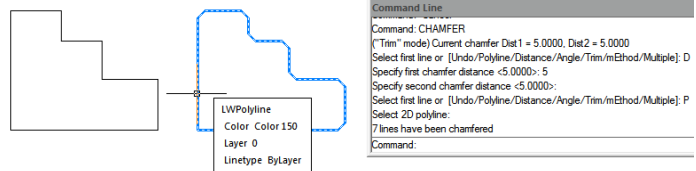

Create Fillets: You can create a fillet using FILLET command. This command can apply to the objects such as arcs, circles, ellipses, lines, polylines, rays, splines or construction lines. A fillet is an arc that connects two objects smoothly and has a specified radius. An inside corner is called a fillet; an outside corner is called a round. Before creating fillets, you should ensure the distance between each vertex is long enough to accommodate the fillet radius in order to insert a fillet arc. When the fillet radius is set to 0, no fillet arcs are inserted. If two polyline segments are separated by one arc segments, system deletes this arc segment and extends the lines to intersect with each other.

To fillet two objects:

- 1.Choose Modify > Fillet from the main menu.
- 2.On the command line, type R (Radius).
- 3.Specify the fillet radius.
- 4.Select the first and second object.

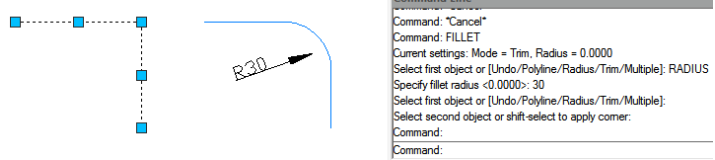

To fillet an entire polyline:

- 1.Choose Modify > Fillet from the main menu.
- 2.On the command line, type P (Polyline).
- 3.Select the polyline.

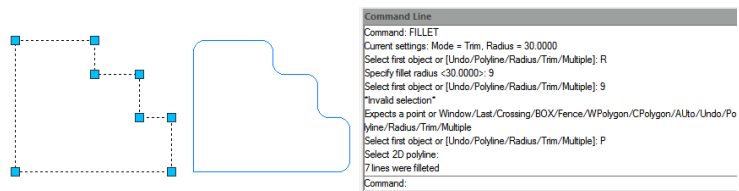

To fillet selected vertices in a polyline:

- 1.Choose Modify > Fillet from the main menu.
- 2.Select one polyline segment where you want to begin the fillet.
- 3.Select the other polyline segment where you want to end the fillet.

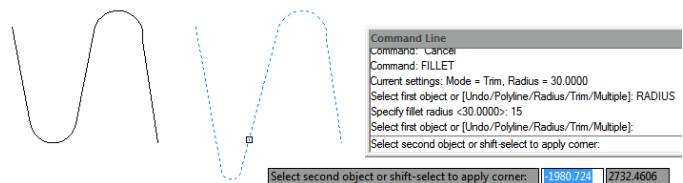

Trim and Extend Filleted Objects: While performing fillet, you can select Trim option to decide whether the selected edges are extended to the endpoints of fillet arcs. By default, all objects except of circles, ellipses, closed polylines and splines are trimmed or extended when performing filleting.

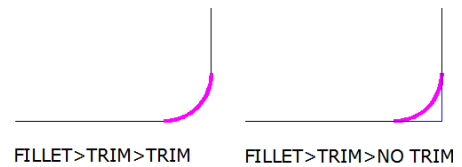

Fillet Line and Polyline Combinations: If the objects to fillet are a line and a polyline, the line or its extension must be intersecting with one of the polyline segments. With Trim option on, the filleted objects join with the filleted arc to form a new polyline.

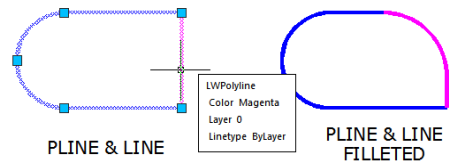

Fillet Parallel Lines: You can fillet parallel lines, rays, and infinite lines. The first entity must be a line or ray, the second entity can be a line, ray, or infinite line. The diameter of the fillet arc is always equal to the distance between the parallel entities. The current fillet radius is ignored.

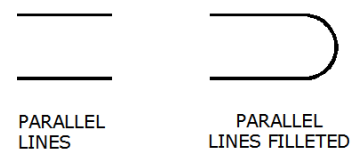

Disassociate Compound Objects: You can convert a complex entity, such as a block or polyline, from a single entity into its component parts. Exploding a polyline, rectangle, donut, polygon, dimension, or leader reduces it to a collection of individual line and arc entities that you can then modify individually. Blocks are converted to the individual entities, possibly including other, nested blocks that composed the original entity.

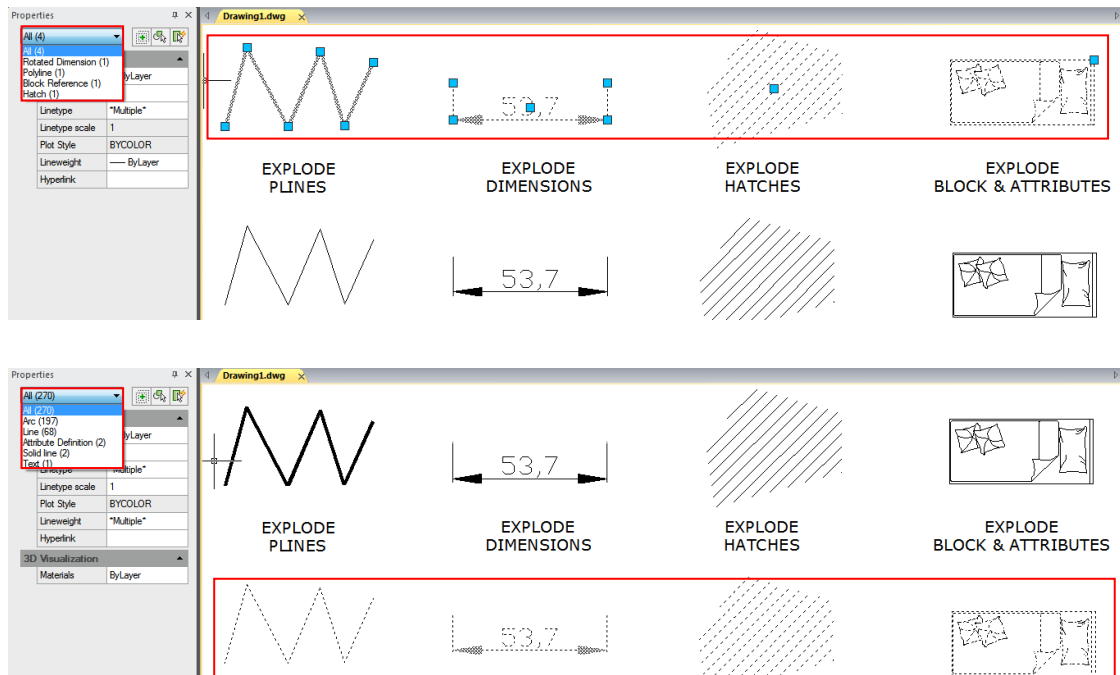

With the following exceptions, exploding an entity usually has no visible effect on a drawing:

- If the original polyline had a width, the width information is lost when you explode it.
- If you explode a block containing attributes, the attributes are lost, but the original attribute definitions are retained.
- Colors, linetypes, lineweights, and print styles assigned BYBLOCK may be different after exploding an entity, because they will adopt the default color, linetype, lineweight, and print style until inserted into another block.

Modify Polylines: Objects such as rectangles, polygons, and donuts, as well as three dimensional objects such as pyramids, cylinders, and spheres, are all editable polylines. To modify a polyline, perform PEDIT command. The available options vary depending on whether the selected polyline is a two dimensional or three dimensional object. If the selected object is not a polyline, the Edit Polyline tool provides the option of turning it into one. You can convert only arcs and lines into polylines. If several arcs or lines are joined endpoint to endpoint, they can all be selected and turned into one polyline.

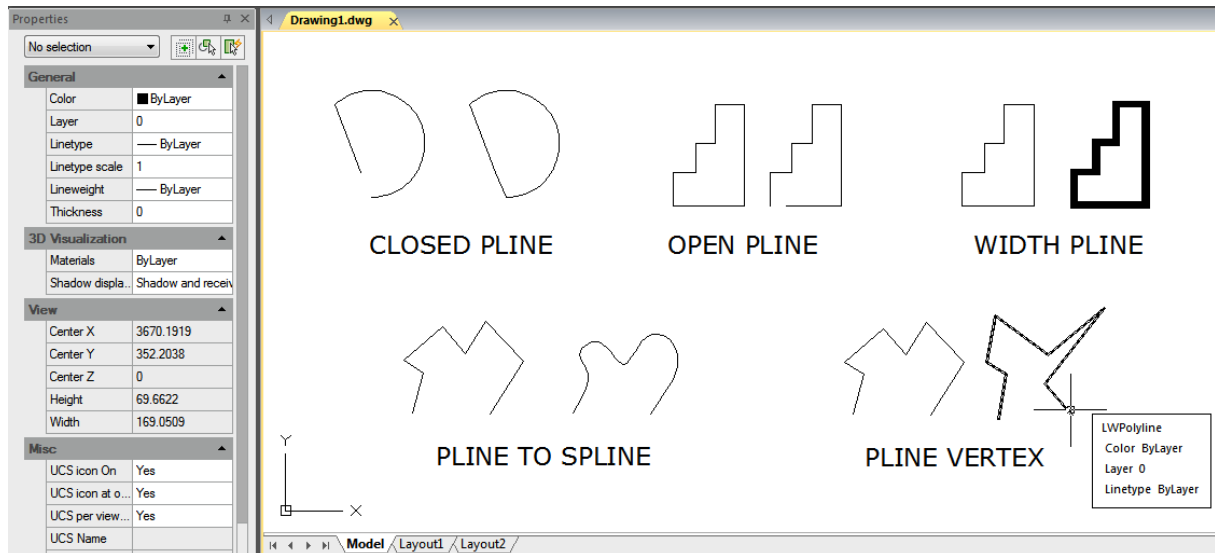

Modify Multilines: You can use the methods such as common editing commands, a multiline editing command and multiline styles to edit multilines or their elements. You can use MLEDIT command to add or delete vertices for a multiline, to control the way two multilines intersected (cross and T shape that can be closed, open or merged), to add multiline style or set multilines from the existing multiline style, such as the number of elements, color, linetype, lineweight and the offset of each element.

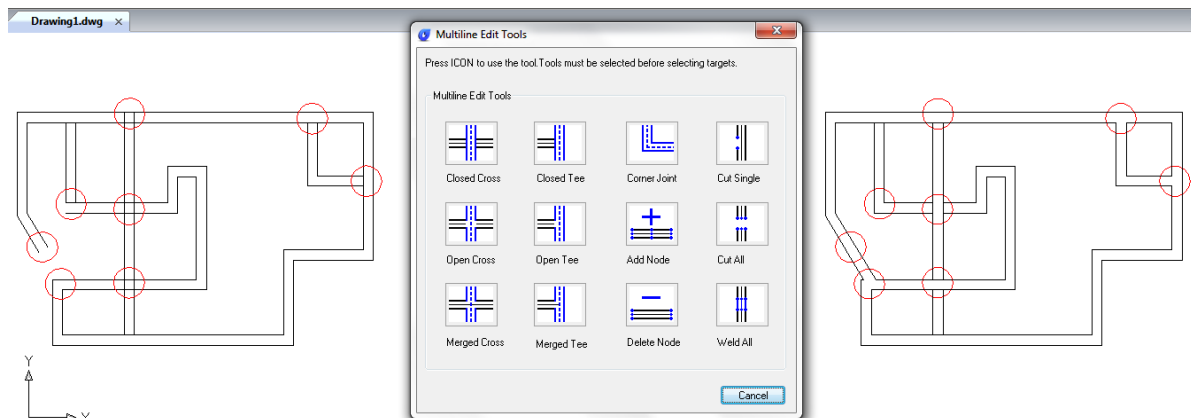

Notes and Labels

Create Text

Create text, multiline text (mtext) and text that includes one or more leader lines.

Single-Line Text: You can use TEXT command to create a single or multiline text. Each line text is an independent object which can be modified. Before typing text, you can specify the text style and the way to align at the prompt of creating text.

Press ENTER if you have typed some characters, and then the command line prompts to input characters for the next row of text. While creating single line text, you are also enabled to extend or compress certain single line text object in specified space to meet with your need by means of selecting Align or Fit option from the TEXT command line prompt.

To create text:

1. Choose Draw > Text > Single Line Text from the main menu.
2. Specify the start point for the text.
3. Specify the height of the text.
4. Specify the text rotation angle.
5. Type the text, and then press Enter at the end of each new line.
6. To complete the command, press Enter again.

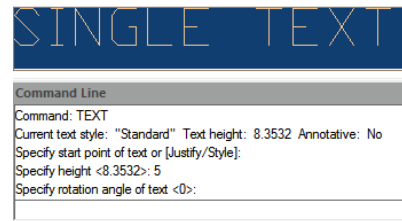

To specify the line text alignment:

1. Choose Draw > Text > Single Line Text from the main menu.
2. On the command line, type J (Justify) and press ENTER.
3. Type an alignment option BR to align text at its bottom-right corner.
4. Type the text, and then press Enter at the end of each new line.
5. To complete the command, press Enter again.

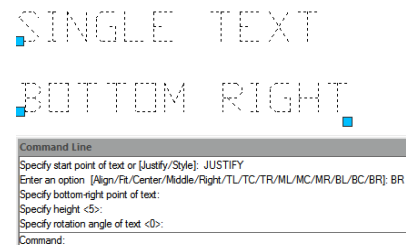

Multiline Text: Multiline text consists of one or more lines of text or paragraphs that fit within a boundary width that you specify. When you create multiline text, you first determine the paragraph's boundary width by specifying the opposite corners of a rectangle. The multiline text automatically wraps so that it fits within this rectangle. After defining the text frame, the system opens the In-Place Text Editor, which is comprised of a text frame and the Text Formatting toolbar. You can type text in the text frame and change the style from the Text Formatting toolbar.

To create multiline text:

1. Choose Draw > Text > Multiline Text from the main menu.
2. Select the first and second corner of the text area.
3. In the Multiline Text window, type the text you want.
4. To create paragraphs, press Enter and continue typing.

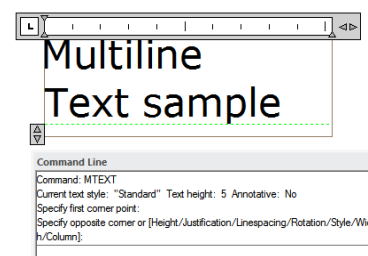

On the toolbar, make format changes as follows:

- 1.To change the font of the selected text, select a font from the list.
- 2.To change the height of the selected text, enter a new value in the Height box.
- 3.To apply color to the selected text, choose a color from the Color list.
- 4.Click OK on the toolbar or Press <Ctrl + Enter>

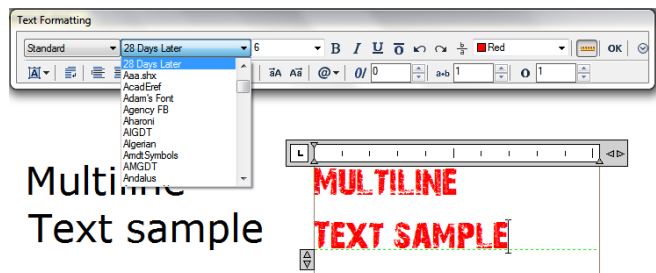

Justify Multiline Text: You can specify the attachment point at the top left, top center, top right, middle left, middle center, middle right, bottom left, bottom center, or bottom right. The multiline text can flow left to right, right to left, top to bottom, or bottom to top.

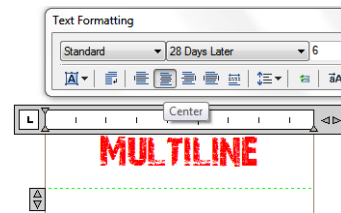

Format Characters within Multiline Text: During creating multiline text, you can assign a new value to the selected objects to overlap the default setting. You can specify underlines, bold, color and fonts for a single or multiple characters, or different text height.

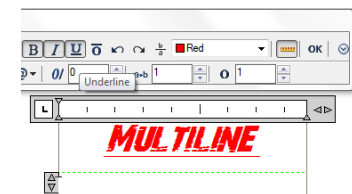

Indent Multiline Text and Use Tabs: You can control the appearance of text objects and create a list by specifying the tap stops and indenting text. The arrowheads on the ruler are used to define the indent of text (first line and paragraph).

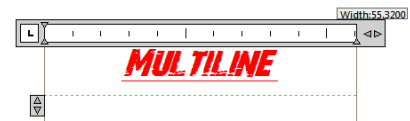

Specify the Line Spacing: The line spacing of multiline texts is the distance between the baseline of one line of text and the baseline of the next line of text. You can right-click in the textbox and choose Paragraph to specify the desired line space when the cursor stays on the text frame.

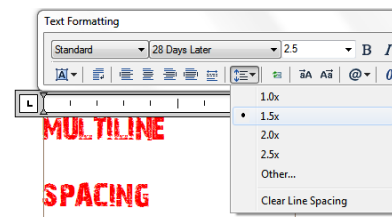

Create Stacked Characters: Stacked text is text or fraction applied to mark tolerance or measure units. Before creating stacked text, you have to use special characters to indicate the stacked place for the selected text. The following contents present the special characters and illustrate how to create stacked text:

- Slash (/): Stacks text vertically and separates them with a horizontal line.
- Pound sign (#): Stacks text diagonally and separates them with a diagonal line.
- Carat (^): Creates a tolerance stack, which is stacked vertically as well as not separated by a line. You can also use Stack button on the toolbar to create stacked text.

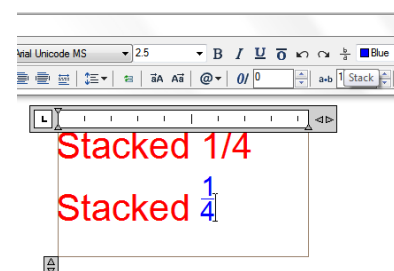

Work with Text Styles: The text style is applied to the text objects. You can use text style to control the text font, size, angle, direction and other features. By default, the current text style is STANDARD, and you have to make other text styles current when you want to apply them. The STANDARD text style has the following default properties:

Setting	Description
Style name	Name with up to 255 characters
Font name	File associated with font
Big Font	Special shape definition file
Height	Character height
Width factor	Expansion/compression characters
Oblique angle	Slant of the characters
Backwards	Backwards text
Upside down	Upside-down text
Vertical	Vertical/horizontal text

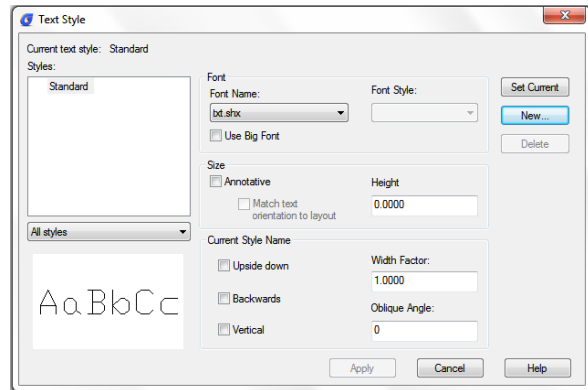

To create a text style:

1. Choose Format > Text Style from the main menu.
2. Click New, type a new text style name, and then click OK.
3. Under Text Measurements, specify the Text Height, Width Factor, and Oblique Angle.
4. Under Text Font, select the name, style, you want to use.
5. Click Apply, and then click OK.

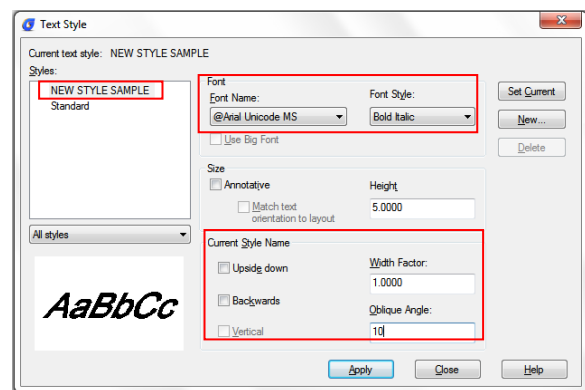

Create Leader

Leaders: A leader is a line or spline with arrowhead at one end, and annotations (Mtext, blocks as well as tolerance) at the other end. Generally, you place an arrowhead at the first point. An annotation, created as dimension text, is placed immediately adjacent to the last point.

To create a leader and an annotation:

1. Choose Dimension > Leader from the main menu.
2. Specify the starting point of the leader.
3. Specify the endpoint of the leader line segment.
4. Specify additional leader line segment endpoints.
5. After you specify the last endpoint, press Enter.
6. Type the annotation, and press Enter to enter the next line of annotation text.
7. Press ENTER to complete the command.



```

Command Line
Command: LEADER
Specify leader start point:
Specify next point:
Specify next point or [Annotation/Format/Undo] <Annotation>:
Specify next point or [Annotation/Format/Undo] <Annotation>:
Specify next point or [Annotation/Format/Undo] <Annotation>: <ORTHO On>
Specify next point or [Annotation/Format/Undo] <Annotation>:
Specify next point or [Annotation/Format/Undo] <Annotation>:
Specify next point or [Annotation/Format/Undo] <Annotation>:
Enter first line of annotation text or <options>: LEADER
Command:
    
```

Modify Text

Change Text: All of text objects can be moved, rotated, deleted and copied, just as like other objects. You can change the properties at the Properties panel. You have two methods to modify single-line text:

- To modify only the content of text, use DDEDIT command.
- To change text style, location, size and content, use PROPERTIES command to open Properties palette, from which, you can make the relevant settings.

To edit single or multiline text:

- 1.Type DDEDIT and then press Enter.
- 2.Select the single line or multiline text.
- 3.If select the single line text, the Edit Text box will pop up, edit the text and then press Enter.
4. If select the multiline text, the In-Place Text Editor will pop, edit the text according as you need.

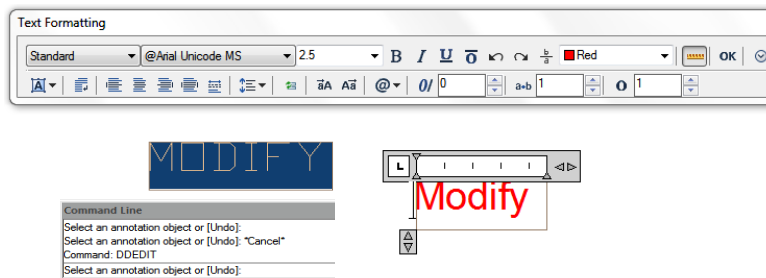

To change single or multiline text properties:

- 1.Select a single line or multiline text object.
- 2.Right-click the selected object and then click Properties on the shortcut menu.
- 3.In the Properties palette, enter any new text in the Text Contents, and then change formatting and other properties as needed.
- 4.You can also do double-click on the multiline text to open the In-Place Text Editor, from which, you can modify the contents and formats of text.

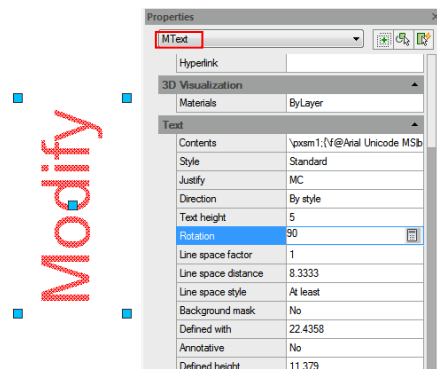
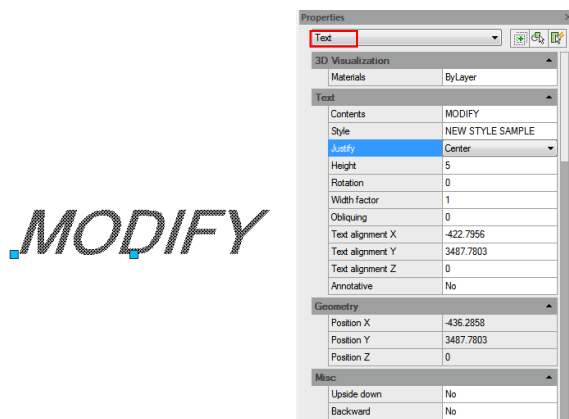
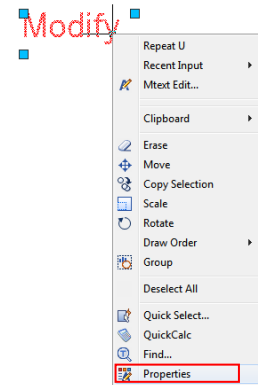

Dimensions and Tolerances

Dimensions indicate the measurement values of objects (e.g. length or width), distance or angles among objects, or the distance between feature point and the specified origin. You can create five basic types of dimensions: linear, angular, radial, diametral and ordinate. Dimensions have several distinct elements: dimension text, dimension lines, arrowheads, and extension lines.

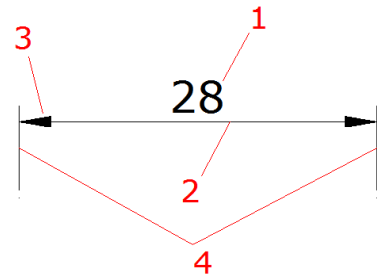

1. **Dimension text:** A character string that usually indicates the measurement value, includes prefixes, suffixes, tolerances, etc.
2. **Dimension line:** Indicates the direction and extent of a dimension. For linear dimensions, it displays as a line, for angular dimensions, it displays as an arc segment.
3. **Arrowhead:** Usually displayed at both end of the dimension line. You can specify various sizes and shapes for arrowheads or tick marks.
4. **Extension lines:** Extend from the object to the dimension line, in order to define dimension ranges.

Create Dimensions

You can create dimensions by selecting the entity to dimension and specifying the dimension line location, or by specifying the extension line origins and the dimension line location.

Horizontal and Vertical Dimensions: As you create linear dimensions, the system automatically applies a horizontal or vertical dimension depending on the specified extension line origins or the location where you select an object. However, you can create a dimension by specifying it be horizontal or vertical.

To create a horizontal or vertical dimension:

1. Choose Dimension > Linear from the main menu.
2. Press Enter, and then select the object to dimension. Or, you can specify the first and second extension line origins.
3. Specify the dimension line location.

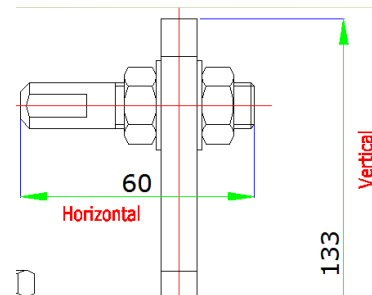

Create Aligned Dimensions: In the aligned dimensions, the dimension line is parallel to the line passing through the extension line origins. The aligned dimension is also parallel to the objects you specify. The system creates the extension lines automatically.

To create an aligned dimension:

1. Choose Dimension > Aligned from the main menu.
2. Press Enter, and then select the object to dimension. Or, you can specify the first and second extension line origins.
3. Specify the dimension line location.

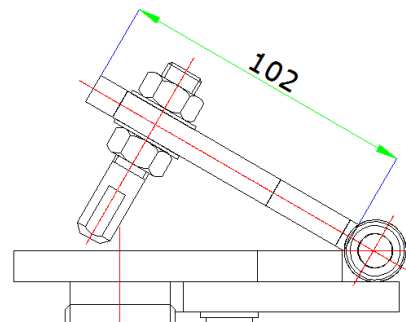

Create Baseline and Continued Dimensions: Both baseline and continued dimensions are multiple linear dimensions. Baseline dimensions are measured from the same baseline and continued dimensions are placed end to end. Before creating either baseline or continued dimension, you have to create a linear, aligned, or angular dimension.

To create a linear baseline dimension:

1. Choose Dimension > Baseline from the main menu.
2. Specify a second extension line origin
3. Select the next extension line origin.
4. Continue selecting extension line origins as required.
5. To end the command, press Enter twice.

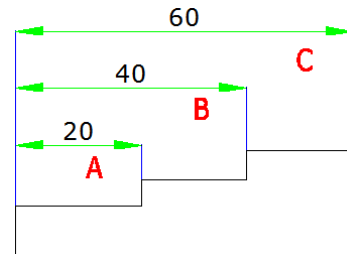

To create a linear continued dimension:

1. Choose Dimension > Continue from the main menu.
2. To select a starting dimension, press Enter.
3. Select the next extension line origin, and then press Enter. Or press Enter, and then select an existing dimension to continue.
5. To add continued dimensions, continue selecting extension line origins.
6. To end the command, press Enter twice.

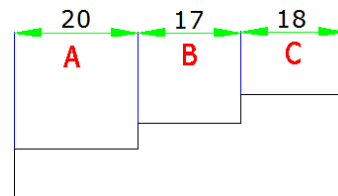

Create Rotated Dimensions: You can create rotated dimensions at a rotated angle you specify using DIMLINEAR Rotated option. An example of a rotated dimension is shown in the following illustration. In this illustration, the specified angle of the rotated dimension is equal to the angle of the slot.

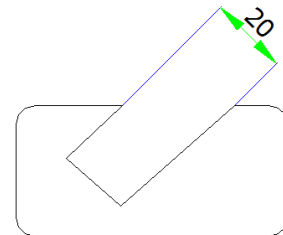

Create Angular Dimensions: Angular dimensions are used to measure the angle between lines or three points. You can dimension objects including circles, arcs, and lines. When you create the angular dimension, you can modify the text content and alignment before placing the dimension line.

To dimension an angle between two lines:

1. Choose Dimension > Angular from the main menu.
2. Select one line.
3. Select the other line.
4. Specify the dimension line location.

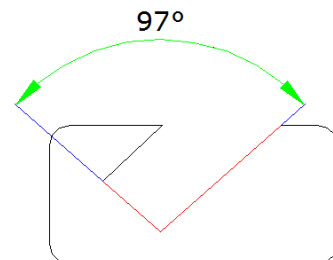

To dimension an angle encompassed by an arc:

1. Choose Dimension > Angular from the main menu.
2. Select the arc.
3. Specify the dimension arc location.

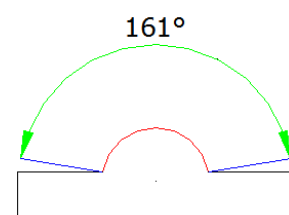

Create Radial Dimensions: You can create radial dimensions for circles or arcs to measure their radial. The radial dimension is a line with an arrowhead that points to a circle or arc.

To create a radial dimension:

1. Choose Dimension > Radius from the main menu.
2. Select the arc or circle.
3. Specify the dimension line location.

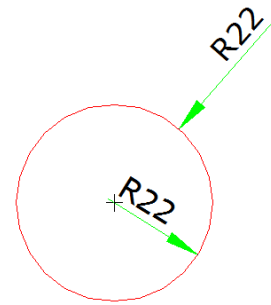

Jogged Dimension: Jogged dimension is namely jogged radius dimension, which is also called "scaled radius dimension". User can specify center position to place the origin of dimension for replacing center point of circle or arc within radius dimension. DIMJOGGED command is useful for creating dimensions in case that the center of circle or arc to be dimensioned is located outside the layout and can't be displayed in its actual position either.

To create a jogged radius dimension:

1. Choose Dimension > Jogged from the main menu.
2. Select a circle or an arc.
3. Select center position as the dimension origin.
4. Specify a point to position the jog symbol.

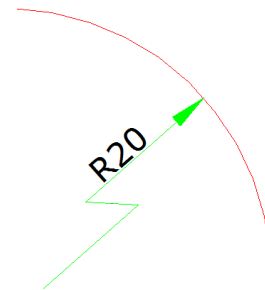

Create Diameter Dimensions: You can create diameter dimensions for circles or arcs to measure their diameters. Creating diameter dimensions resembles creating radial dimensions. You can create various diameter dimensions based on the location and size of circles or arc, and the settings of the dimension style.

To create a diameter dimension:

1. Choose Dimension > Diameter from the main menu.
2. Select the arc or circle.
3. Specify the dimension line location.

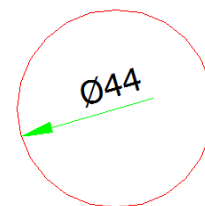

Create Ordinate Dimensions: Ordinate dimensions are used to measure the perpendicular distance from an origin point called the datum to a feature, such as a hole in a part. Ordinate dimensions are comprised of a leader line with an X or Y value, and leaders are drawn along the orthographic direction at the current UCS.

To create an ordinate dimension:

1. Choose Dimension > Ordinate from the main menu.
2. Select the point for an ordinate dimension.
3. Specify the ordinate leader endpoint.

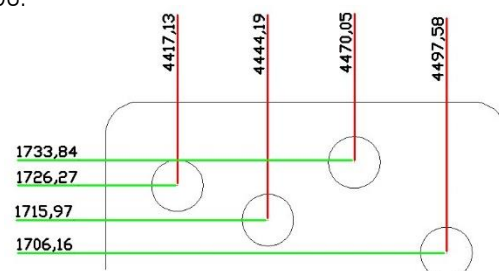

Create Quick Dimension: Creates or edits a series of dimensions quickly by typing QDIM command.

To create a quick dimension:

1. Choose Dimension > Quick Dimension from the main menu.
2. Select the geometry to dimension, and then press Enter.
3. On the command line, it will display "Specify dimension line position, or [Continuous/Staggered/Baseline/Ordinate/Radius/Diameter/datumPoint/Edit/Settings] <Continuous>:". You can perform the operation as desired. The default is Continuous.

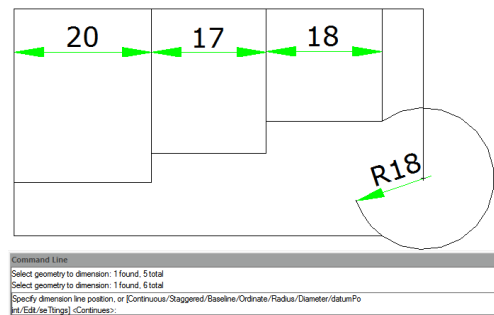

Create Arc Length Dimension: Arc length dimension is available for measuring the arc length of arc or polyline arc segment. GstarCAD creates arc length dimension by specifying extension line position directly after selecting arc by default. And use an arc symbol as arc length dimension, which is differing from linear dimension and angular dimension.

To create an arc length dimension:

1. Choose Dimension > Arc Length from the main menu.
2. Select an arc or polyline arc segment.
3. Specify a point to position the arc length dimension.

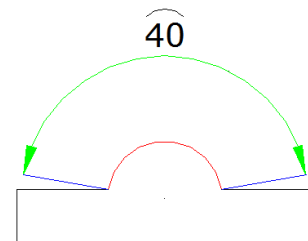

Use Dimension Styles

You can control the appearance of dimensions by changing settings to help maintain dimensioning standards, you can store these settings in dimension styles.

Dimension Styles: You can create, save, restore, and delete named dimension styles. Dimension styles provide a way for you to change various settings that control the appearance of dimensions. You can change the following settings:

- Extension lines, dimension lines, arrowheads, center marks or lines, and the offsets between them.
- The positioning of the parts of the dimension in relation to one another and the orientation of the dimension text.
- The content and appearance of the dimension text and units of the dimension value.

To create a dimension style:

1. Choose Dimension > Style from the main menu.
2. In the Dimension Style Manager dialog box, click New.
3. Type the name of the new dimension style, and choose which style started with and what kind of dimension used for. Then click Continue.
5. In the New Dimension Style dialog box, change the dimension settings as necessary. Repeat this step for each tab, as needed.
6. To end the command, click OK.

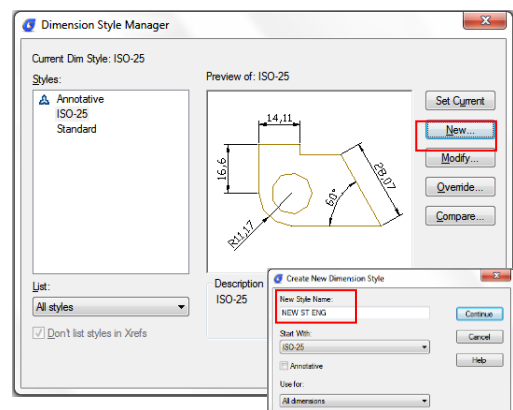

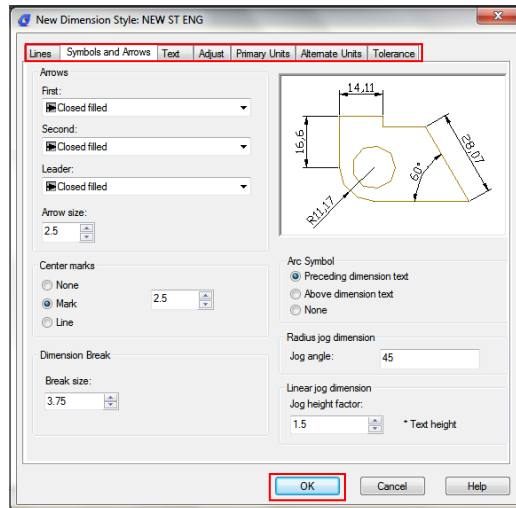

To rename a dimension style:

1. Choose Dimension > Style from the main menu.
2. In the Styles list do one of the following:
 - Double click the required style.
 - Right click on the required style name, and then choose Rename.
3. Type the new name.
4. Click Close to exit.

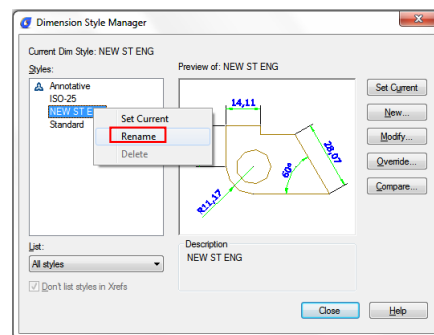

To delete a named dimension style:

1. Choose Dimension > Style from the main menu.
2. In the Styles list, right click on the required style name, and then choose Delete.
3. Click Close to close.

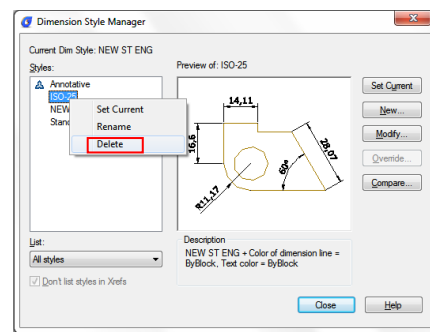

To display information about the current style:

1. Choose Dimension > Style from the main menu.
2. In the Dimension Style Manager dialog box, click Compare.
3. In the Compare Dimension Style dialog box, choose the same dimension style from the Compare and With pulldown list. All properties for specified dimension style will be displayed.
4. If you want to know the different information between two styles, choose one style in the Compare box, choose the other in the With box, and then you will see difference in the following tab.
5. Click Close to close.

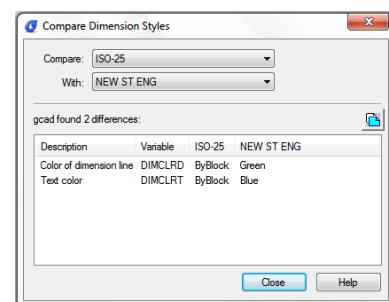

Modify Dimension Lines: On the Line tab of the Modify Dimension Style dialog box, you can set the color of dimension lines, lineweight, ticks beyond extend line, baseline spacing, and visibility.

Modify Extension Lines: Extension lines have the following properties: color, lineweight, distance beyond extension lines, offset from start of extension lines, and visibility. You can set these properties on the Line tab of the Modify Dimension Style box:

- The distance beyond extension lines means that how far the extension lines extend beyond the dimension line.
- Start offset is the distance between the extension line origin and the start of the extension line, also called extension origin offset.

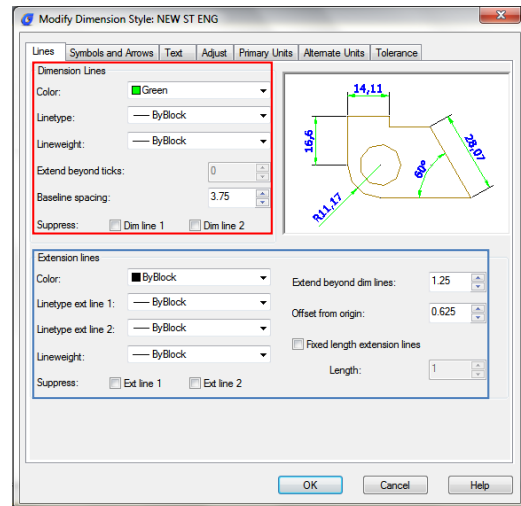

Choose Dimension Arrowheads: You can control the appearance and size of arrowheads or hook marks placed at the ends of dimension lines. You can specify different arrowheads for both ends of a dimension or leader lines. The First arrow is toward the first extension line; The Second arrow is toward the second extension line.

To choose an arrowhead:

1. Choose Dimension > Style from the main menu.
2. In the Dimension Style Manager dialog box, select the style you want to change and click Modify button.
3. In the Modify Dimension Style dialog box, click the Symbols and Arrows tab.
4. Make your selections under the Arrowheads.
5. Click OK and then choose CLOSE to exit.

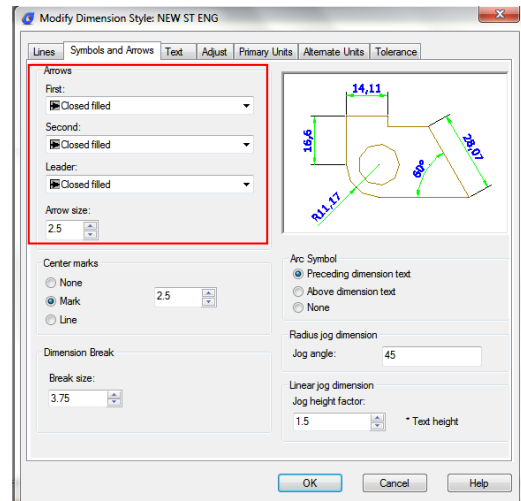

Fit Dimension Text within Extension Lines: When there is no enough space between extension lines to accept both of dimension text and arrowheads, you have to adjust one or both of their placement. By default, the system fits them best depending on the available space. You can specify other methods to place them on the Adjust tab of the Modify Dimension Style dialog box.

To format dimensions:

1. Choose Dimension > Style.
2. In the Dimension Style Manager dialog box, select the style you wish to change and choose Modify.
3. In the Modify Dimension Style dialog box, click the Adjust tab.
4. Under Fit Options and Text Placement, select an option.
5. Click OK and choose Close to exit.

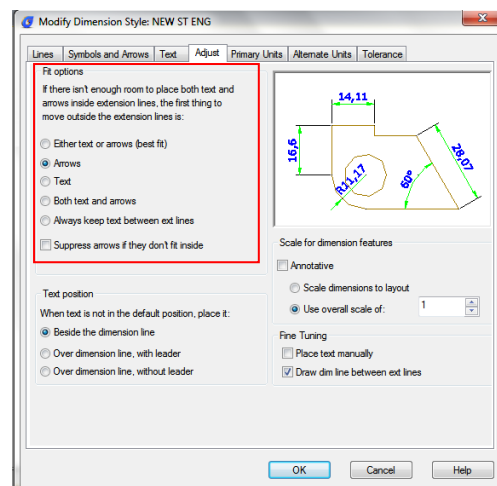

Fit Diameter Dimension Text: You can create various diameter dimensions based on text placement, fit options and the selection of "Always keep text between ext lines" option on the Adjust tab.

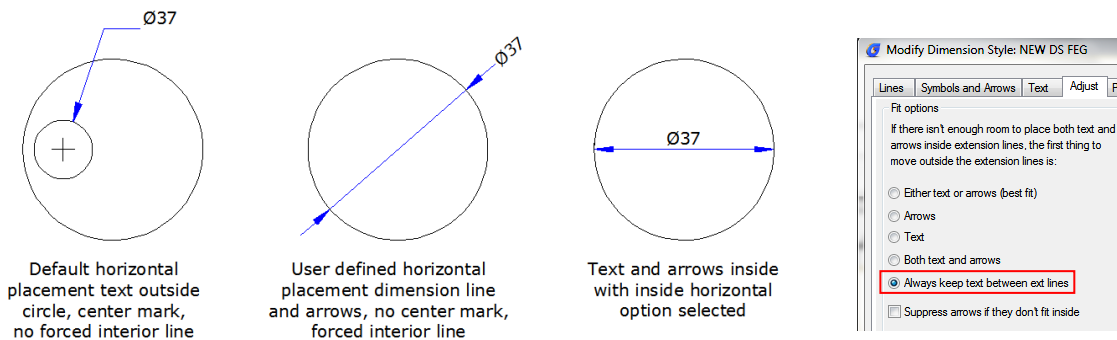

Align Dimension Text: Whether the text is inside or outside the extension line, it has no effect on the justification of dimension text. You can choose whether the text is align with the dimension lines or remains horizontal.

To align dimension text with the dimension line:

1. Choose Dimension > Style.
2. In the Dimension Style Manager dialog box, select the style you wish to change and choose Modify.
3. In the Modify Dimension Style dialog box, click the Text tab.
4. Make your selections.
5. Click OK and choose Close to exit.

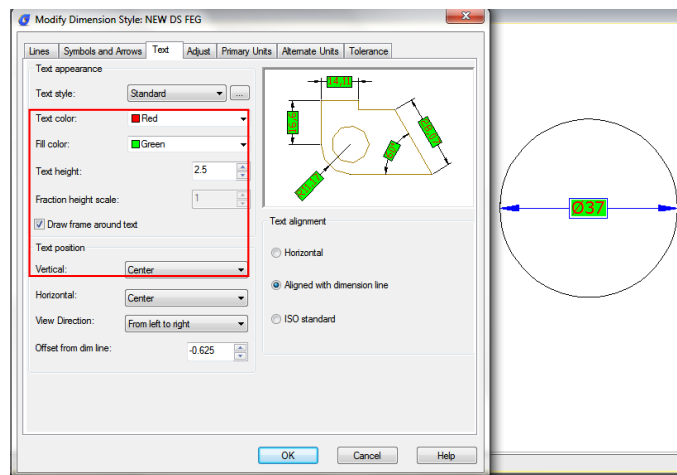

Position Dimension Text Vertically:

The vertical text placement is the position of the text relative to the dimension. You can place text above, below, or centered within the dimension line, or use the JIS dimensions.

Position Dimension Text Horizontally:

The position of text along the horizon is relation to the extension lines. The settings include Centered, At Ext Line 1, At Ext Line 2, Over Ext Line1, and Over Ext Line2.

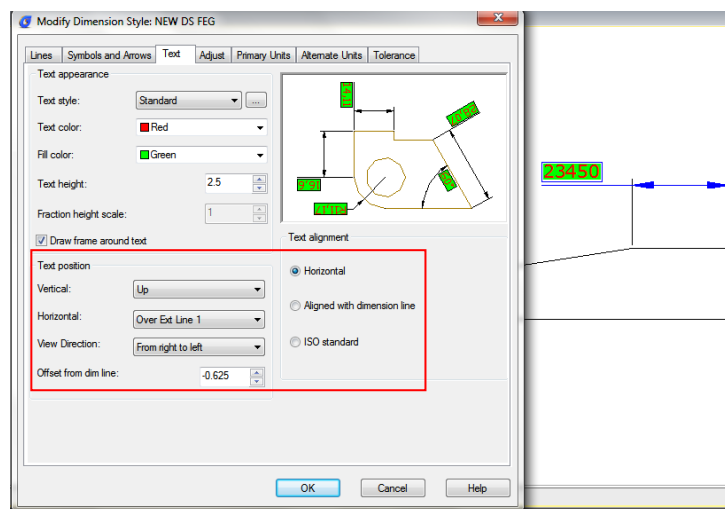

Dimension Units: You can determine the appearance and format of the primary and alternate dimension units. You can set the primary units for linear and angular dimensions, including unit format, numeric precision and so on. These settings control the display of dimension values.

To round off dimensions:

1. Choose Dimension > Style from the main menu.
2. In the Dimension Style Manager dialog box, select the style you wish to change and choose Modify.
3. In the Modify Dimension Style dialog box, click the Primary Units tab.
4. In the Linear Dimensions and Angular Dimensions fields, type or select the nearest value to which you want to round off dimensions.
5. Click OK and choose Close to exit.

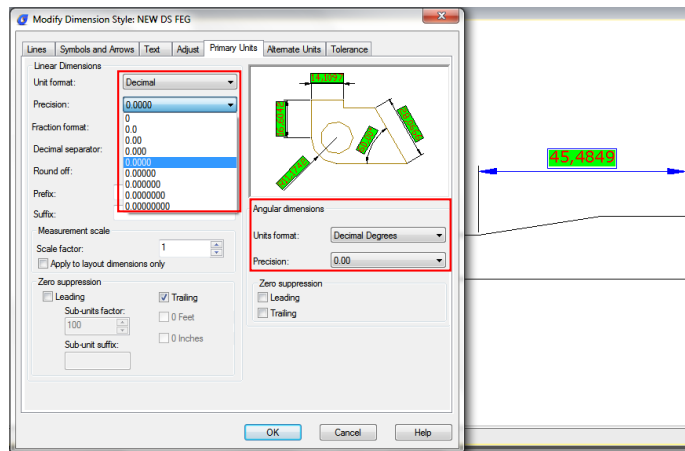

Alternate Units: You can create a dimension in two systems of measurement simultaneously in a drawing. This feature is helpful when you want to add feet and inches dimensions in a drawing created using metric units. The alternative units appear in square brackets ([]) in the dimension text. Alternative units can be applied to linear dimensions only. The precision for alternate units determines the number of decimal places.

To create an alternate dimension:

1. Choose Dimension > Style.
2. In the Dimension Style Manager dialog box, select the style you wish to change and choose Modify.
3. In the Modify Dimension Style dialog box, click the Alternate Units tab.
4. Click the Display Alternate Units check box.
5. Make your selections.
6. Click OK and choose Close to exit.

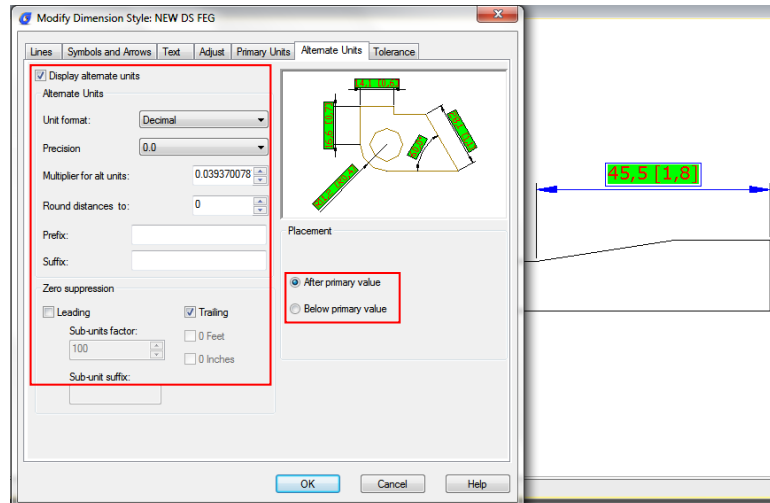

Display Lateral Tolerances: Lateral tolerance represents a value that the amount a measured distance can vary. You can control the degree of accuracy needed for a future by specifying tolerances in manufacturing. These dimension tolerances indicate the largest and smallest permissible size. You can also apply geometric tolerances to indicate deviations of form, profile, location, orientation, and runout.

Deviation tolerances represent with the plus and minus values that are appended to the dimension values. If the deviation tolerances are equal, the \pm signs precede them and they are known as symmetrical. Otherwise, the plus value locates above the minus value.

The vertical placement of tolerance values that is relative to the main dimension text can be specified. For example, you can align the tolerances with the top, middle, or bottom of the dimension text.

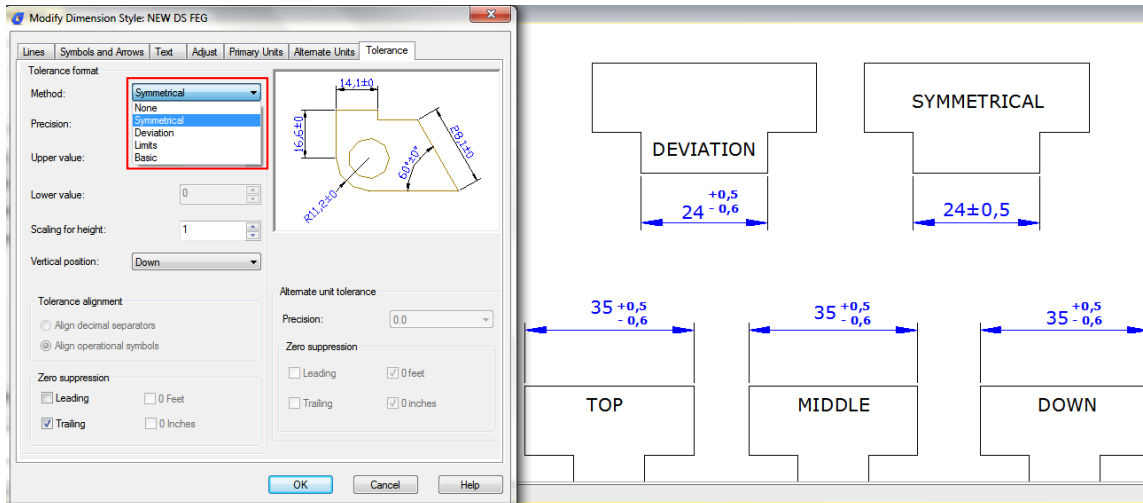

Set the Scale for Dimensions: Setting dimension scale depends on the method you use to lay out and plot drawings. Dimension scale has effects on the size of dimension geometry relative to the objects in the drawing. In addition to text height and arrowhead size, dimension scale affects offsets in dimension as well, such as the extension line origin offset. When you create dimensions, it's recommended to set the size and offset to values that represent their actual plotted size. However, the tolerances, measured lengths, coordinates, and angles cannot be applied to the overall scale factor. The method of creating dimensions in a drawing layout is shown as follows:

-**Dimension in model space for plotting in model space.** If you want to create dimensions that are scaled correctly for plotting, you have to set the system variable DIMSCALE to the inverse of the desired plot scale. For example, if the plot scale is 1/4, you have to set DIMSCALE to 4.

-**Dimension in model space for plotting in paper space.** If you want to create dimensions that are scaled automatically for display in a paper space layout, you have to set the DIMSCALE to 0. This method is useful when you encounter the following situations: the dimensions in a drawing need to be referenced by other drawings (xrefs); when you create isometric dimensions in 3D isometric views. To prevent the dimensions in one layout viewport from being displayed in other layout viewports, it's recommended to create a dimensioning layer for each layout viewport that is frozen in all other layout viewports.

-**Dimension in layouts.** You can create dimensions in paper space by selecting model space objects or by specifying object snap locations on model space objects. The dimensions created in a paper space layout do not need additional scaling: there is no need to change the default value of DIMLFAC and DIMSCALE.

Modify Existing Dimensions

You can modify all components of the existing dimension objects in a drawing either individually or by using dimension styles.

Modify Dimension Style:

You can modify all of properties of the existing dimension objects in a drawing using dimension styles. You can also create a dimension style override to temporarily change a dimensioning system variable without changing the current dimension style. If a dimension style is changed, the dimension associated with that dimension style updates automatically.

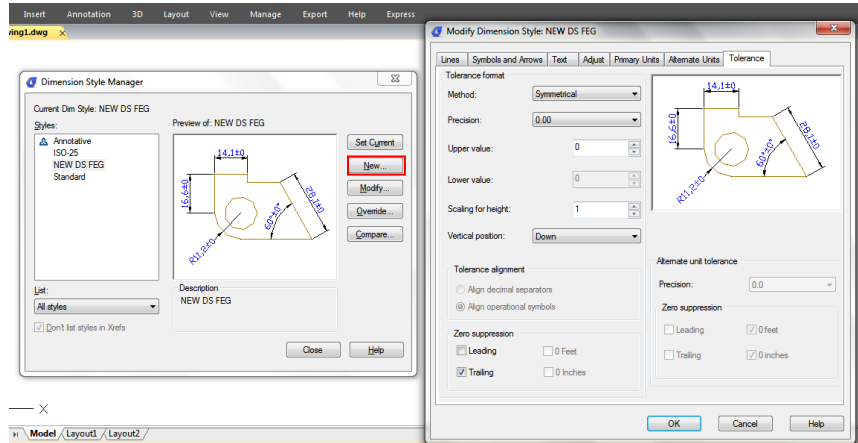

Make Dimensions Oblique: Extension lines are normally created at a perpendicular angle to the dimension line. You can change the angle of the extension lines, however, so that they tilt relative to the dimension line.

To make oblique extension lines:

1. Choose Dimension > Oblique from the main menu.
2. Select the linear dimension, and then press Enter.
3. Type the obliquing angle, and then press Enter.

Remark: To align the oblique angle if you don't know the exact measurement, use snaps to pick two points on the entity.

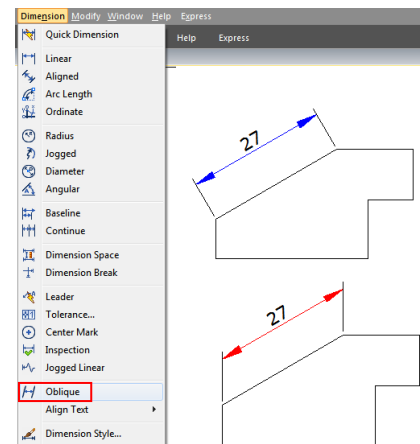

Dimension Jogged Linear: The DIMJOGLINE command is available for adding or removing jog symbol for linear dimensions. The jog symbol is default to be placed at the center point between first extension line and text. To relocate jog symbol, you can adjust the position of dimension text or specify new position to locate jog after reselecting dimension.

To add a jog to linear dimension:

1. Choose Dimension > Jogged Linear from the main menu.
2. Select a linear dimension.
3. Specify a point on the dimension line to determine the jog symbol, or press ENTER directly to position the jog symbol in default place.

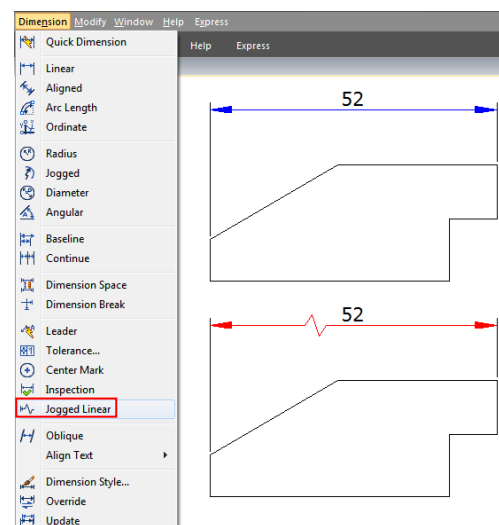

Dimension Inspection: Dimension inspection is created to transmit the frequency of inspecting the part being dimensioned, the dimension value and parts tolerance are ensured to be within specified range. Dimension inspection is composed by a frame and internal text and contains utmost three kinds of information field: inspection tag, dimension value and inspection rate.

Inspection tag, used for mark the text of dimension inspection is located at the left side within the inspection frame.

Dimension value is the value before adding dimension inspection, which is located at the central part of the inspection dimension including tolerance, text and measurement value.

Inspection rate is expressed by percentage, which is located at the right side within the inspection frame, indicates required frequency of the part being created.

To create an inspection dimension:

- 1.Choose Dimension > Inspect from the main menu.
- 2.In the Inspection Dimension dialog box, click Select Dimensions button.
- 3.Select dimensions to add dimension inspection, and then press ENTER to finish selection and return to the dialog box.
- 4.Select a shape for frame from the Shape option.
- 5.Click Label option to input label in the text box.
- 6.Click Inspection Rate option to input a value in the text box.
- 7.Click OK.

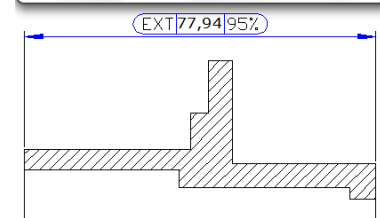
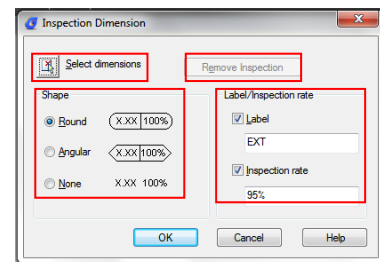

To remove an inspection dimension:

- 1.Choose Dimension > Inspect from the main menu.
- 2.In the Inspection Dimension dialog box, click Select Dimensions button.
- 3.Select dimensions to remove dimension inspection, and then press ENTER to finish selection and return to the dialog box.
- 4.Click Remove Inspection button.
- 5.Click OK.

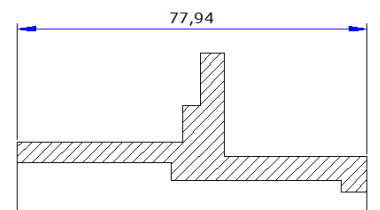

Adjust Dimension Space: Once you have created multiple paralleled linear dimensions or angular dimensions, you can adjust the space among these paralleled lines with an equal value either default or specified. DIMSPACE command adjust the space among paralleled linear or

angular dimensions or overlapped dimensions automatically in case that the original space is not equal values. If you set the space value to 0 when adjusting space among dimensions, you can align selected dimensions at the dimension line as well.

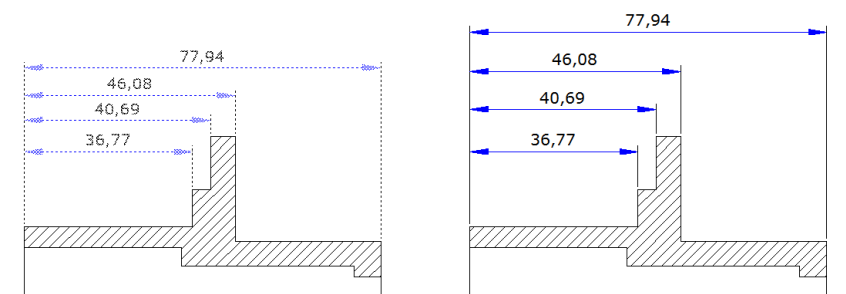

Add Geometric Tolerances

Geometric tolerances show acceptable deviations of form, profile, orientation, location, and runout of a feature. You add geometric tolerances in feature control frames. These frames contain all the tolerance information for a single dimension. Geometric tolerances can be created with or without leader lines, you can create them with TOLERANCE or LEADER command.

A feature control frame consists of two or more components. The first feature control frame contains a symbol that represents the geometric characteristic to which a tolerance is being applied, for example, location, profile, form, orientation, or runout. Form tolerances control straightness, flatness, circularity and cylindricity; profiles control line and surface. In the illustration, the characteristic is position.

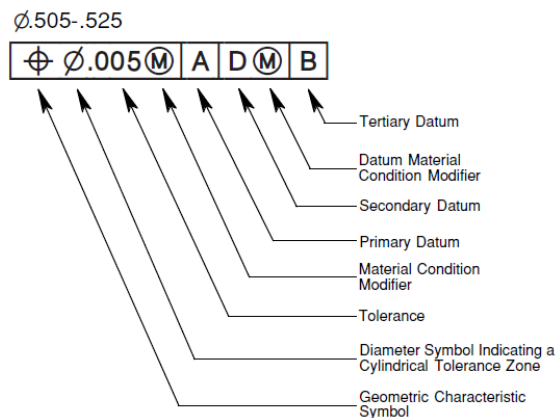

Geometric Tolerance Dialog Box: Specifies the symbols and values for a feature control frame.

1. Geometric Characteristics symbol (menu)
2. Tolerance Zone form (toggle)
3. Tolerance zone value
4. Material condition symbol (menu)
5. Datum reference 1 of 3
6. Datum reference 2 of 3
7. Projected tolerance zone symbol (toggle)
8. Projected tolerance zone value
9. Datum identifier

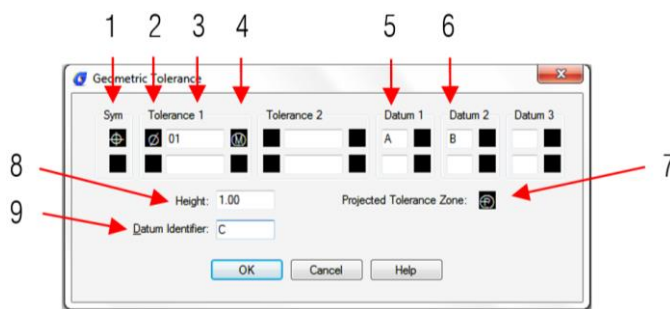

Geometric Tolerance Symbols: The geometric tolerance symbols and their characteristics are shown in the following.

- | | |
|--|--|
| <ol style="list-style-type: none"> 1. Position (Location) 2. Concentricity or Coaxiality (Location) 3. Symmetry (Location) 4. Parallelism (Orientation) 5. Perpendicularity (Orientation) 6. Angularity (Orientation) 7. Cylindricity (Orientation) 8. Flatness (Orientation) 9. Circularity or roundness (Form) 10. Straightness (Form) 11. Profile of a surface (Profile) | <ol style="list-style-type: none"> 12. Profile of a line (Profile) 13. Circular runout (Runout) 14. Total runout (Runout) |
|--|--|

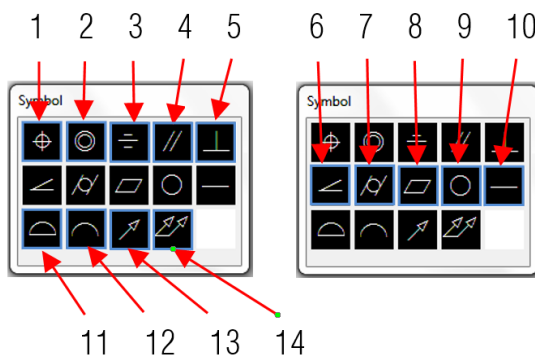

Material Conditions: Depending on control type, you can add a diameter symbol prior to the tolerance value, and specify a material condition symbol behind this value. You can apply material conditions to features that can vary in size.

Datum Reference Frames: A datum reference consists of values and modifying symbols. A datum is a theoretically exact geometric reference that measures and verifies a theoretically exact point, axis, or plane. The system provides up to three datum reference letters and relative symbols followed by the tolerance value.

Projected Tolerance Zones: Projected tolerance zones control the height of the fixed perpendicular part of the extension area, and control tolerance accuracy by positional tolerances. Before you set the symbol to projected tolerance zones, you set a height value to specify the minimum projected tolerance zone.

Composite Tolerances: A composite tolerance consists of two tolerances that applied to the same geometric characteristic of a feature or for features that have different datum requirements. Before you create a dimension and add a composite tolerance for a drawing, you have to specify the first line of a feature control frame and then choose the same geometric characteristic symbol for the second line of the feature control frame. The specified geometric symbol compartment is extended over both lines. Then you can create a second line of tolerance symbols.

To add a geometric tolerance:

1. Choose Dimension > Tolerance from the main menu.
2. In the Geometric Tolerance dialog box, click the first square under Sym and select a symbol to insert.
3. Under Tolerance 1, click the first black box to insert a diameter symbol.
4. In the Text box, type the first tolerance value.
5. To add a material condition, click the second black box and click a symbol to insert it.
6. Under Tolerance 2, repeat steps 3 through 5 to add a second tolerance value.
7. Under Datum 1, Datum 2 and Datum 3, enter the datum reference letter.
8. Click the black box to insert a material condition symbol for each datum reference.
9. In the Height box, type a projected tolerance zone height value, if appropriate.
10. To insert a projected tolerance zone symbol, click the Projected Tolerance Zone box.
11. In the Datum Identifier box, add a datum value and then click OK.
12. In the drawing, specify the location of the feature frame.

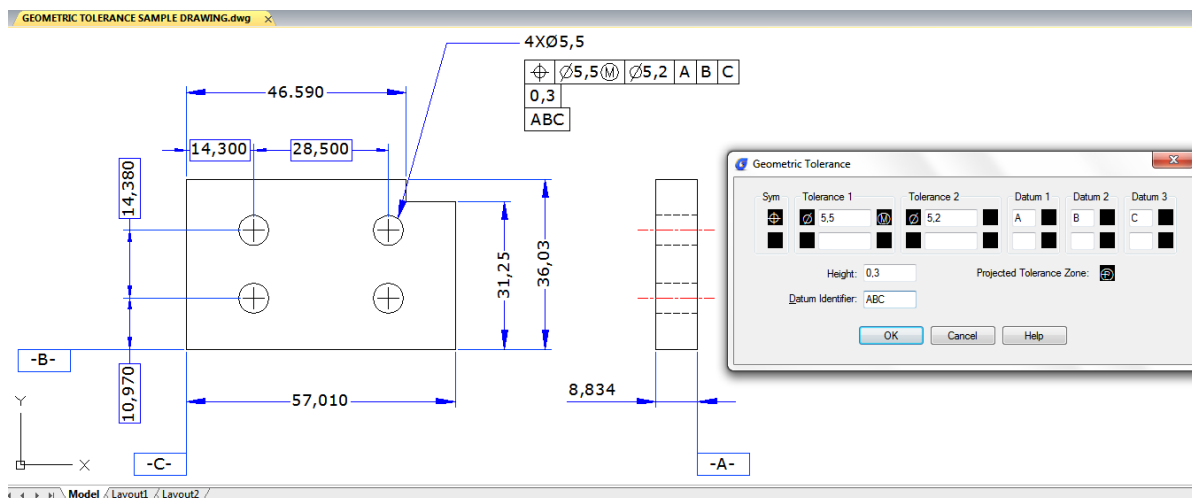

Blocks, Attribute and Xrefs

Create and Insert Blocks

Usually, blocks are several objects combined into one that you can insert into a drawing and manipulate as a single object. Blocks can help you better organize your work, quickly create and revise drawings, and reduce drawing file size.

Create Blocks: Usually, blocks are several objects combined into one that you can insert into a drawing and manipulate as a single object. A block can consist of visible objects such as lines, arcs, and circles, as well as visible or invisible data called attributes. Blocks are stored as part of the drawing file. You can use several methods to create blocks:

-Combine objects to create a block definition in your current drawing.

-Create a drawing file and later insert it as a block in other drawings.

To create a block for use within a current drawing:

1. Choose Draw > Block > Make from the main menu.
2. In the Block Definition dialog box, enter a block name in the Name box.
3. Click Pick point button to specify the insertion point for the block in the drawing area.
4. Click Select objects button to select the objects for the block, then press Enter after selection. Then click OK button.

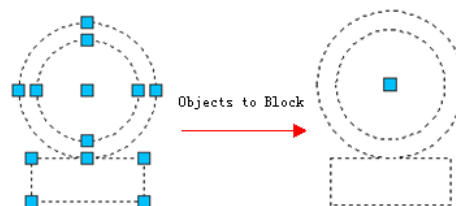
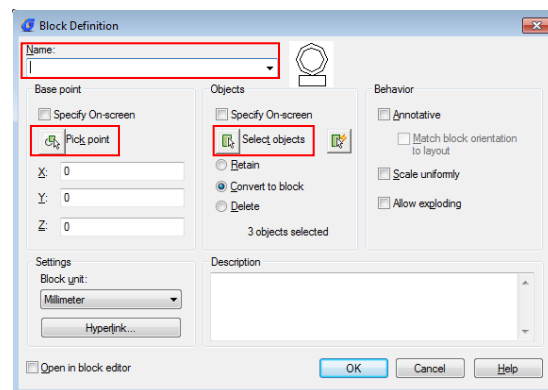

Create Nested Blocks: You can define blocks and other blocks as nested blocks so as to simplify the organization of complicated blocks. With nested blocks, you can build a single block out of several components. But you should notice that blocks that reference themselves cannot be inserted.

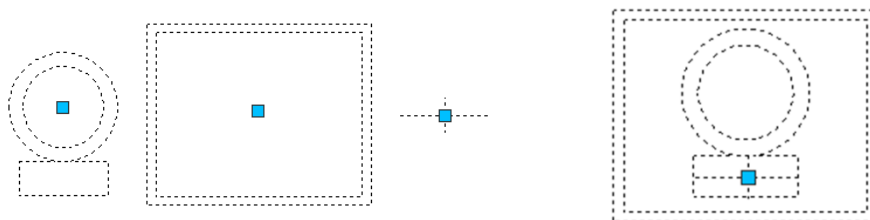

Create Drawing Files for Use as Blocks: You can create a block as a separate drawing file that you can insert into other drawings.

To save a block as a separate drawing file:

1. On the command line, type WBLOCK.
2. Under Source area, choose one of the following:
 - Block:** Saves existing block object to a separate drawing file.
 - Entire drawing:** Saves the entire drawing to a separate drawing file.
 - Objects:** Saves those objects you select to a separate drawing file.
3. Under Destination area, type the name of the drawing file you want to create and choose the saved path, click OK to save.

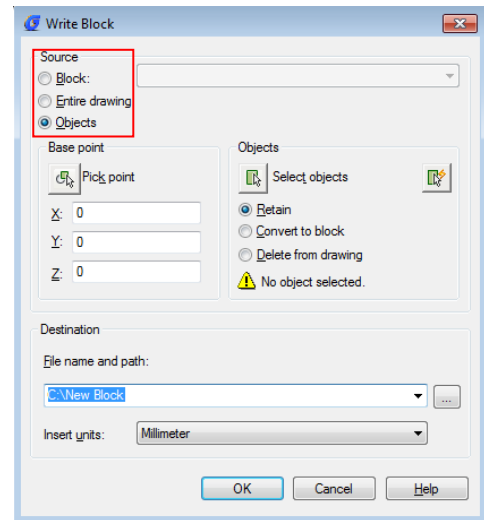

Change the Base Point of Drawings to Be Used as Blocks: When inserting a drawing file into another drawing as a block, by default, system uses the origin (0,0,0) of WCS as the base insertion point. To specify different insertion point, you can use BASE command. Next time you insert the same block, system uses the new insertion point by default.

Update Changes in the Original Drawing: Once the drawing file has been inserted into another drawing as a block, the original drawing changes as well. But the block having been inserted will not change. If the block happens to change along with the original drawing, you should attach it as external reference but not as a block.

Use Paper Space Objects in Blocks: Objects created in paper space are not contained in the block when it is being inserted into the drawing. You can convert the objects in paper space as block or save as an individual drawing file before inserting into other drawings.

Insert Blocks: You can insert blocks and other drawings into the current drawing. When you insert a block, it is treated as a single object. When you insert a drawing, it is added to the current drawing as a block. You can then insert multiple instances of the block without reloading the original drawing file. If you change the original drawing file, those changes have no effect on the current drawing unless you redefine the block by reinserting the changed drawing.

To insert a block:

1. Choose Insert > Block from the main menu.
2. In the Insert Block dialog box, under Insert, click Block Name.
3. In the Name box, select the name of the block you want to insert.
4. If you want to use the pointing device to specify the insertion point, scale, and rotation, select Specify On-Screen. Otherwise, enter values in the Insertion Point, Scale, and Rotation boxes.
5. Click OK to insert.

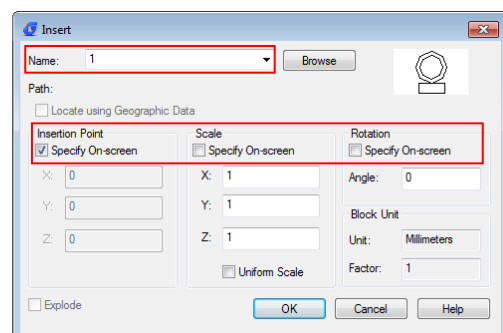
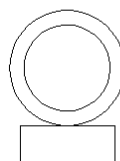

To insert an entire drawing into the current drawing:

1. Choose Insert > Block from the main menu.
2. Click Browse to specify the file from the Insert Block dialog box.
3. You can use the default insertion point, scale, and rotation or select Specify On-Screen and enter values in the Insertion Point, Scale, and Rotation boxes.
4. If you want the objects in the block to be inserted as individual objects instead of as a single block, select Explode. Precondition is the block you created is allowed to explode.
5. Click OK to insert.

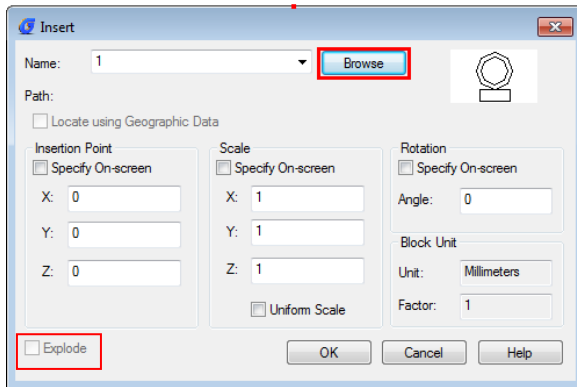

Modify a Block Definition: You can redefine all instances of a block within the current drawing. To redefine a block that was created in the current drawing, you create a new block using the same name. You can update all the blocks in the current drawing by redefining the block. If the block was inserted from a separate drawing file that was subsequently updated, reinsert that block to update all other instances in the current drawing.

To redefine a block in the current drawing:

1. Choose Draw > Block > Make from the main menu.
2. In the Block Definition dialog box, type the name of the block you want to redefine in the Name box.
3. Click Pick point button to specify a point as the insertion point for the block in the drawing area.
4. Click Select objects button to select the objects for the block, and then press Enter after selection.
5. Click OK.
6. Click Yes in the prompt box that displays to redefine the block in the current drawing.

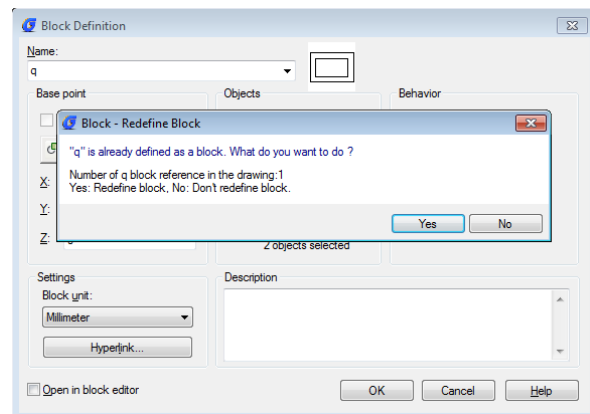

Remove Block Definitions: Too many block definitions in a drawing file may affect the drawing size. To reduce the size of a drawing, you can remove unused block definitions. Erasing a block reference from a drawing may delete the block reference but retain the block definitions in the block definition table. Using PURGE command can help removing unused block references from your drawing in order to reduce the drawing size. You should erase all references from a block before you can purge the block definition.

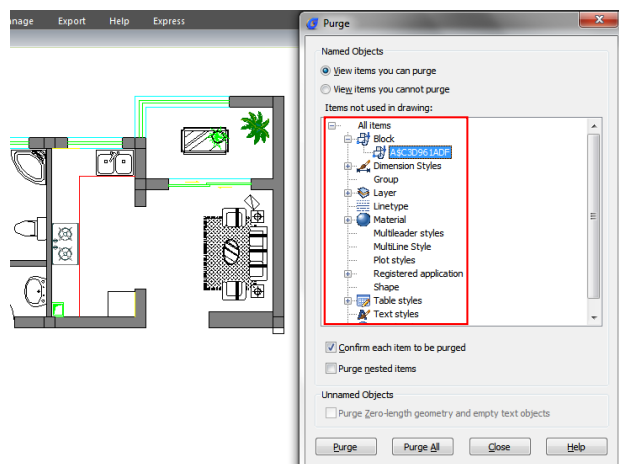

Define and Use Block Attributes: An attribute is a particular object that you can save as part of a block definition. Attributes consist of text-based data. You can use attributes to track such things as part numbers and prices. Attribute values are either fixed or variable.

To define an attribute:

1. Choose Draw > Block > Define Attributes from the main menu.
2. Under the Attribute, type the tag, prompt, and default text.
3. Under Insertion Point, specify the location of the attribute, or click Specify on-screen to select a point in the drawing.
4. Under Mode, select the optional attribute modes.
5. Under Text Settings, specify the text characteristics.
6. To add the attribute to the drawing, do one of the following:
 - Click Define to add the attribute and keep the dialog box active so you can define another attribute.
 - Click Define and Exit to add the attribute and end the command.

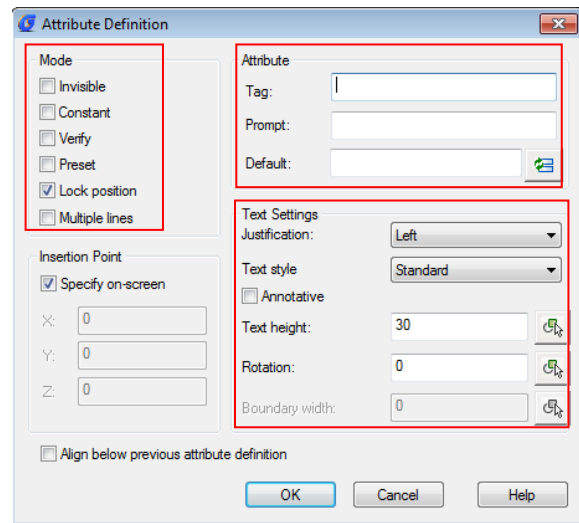

To edit an attribute definition:

1. On the command line, type DDEDIT.
2. Select the attribute definition text to edit.
3. Modify the attribute tag, prompt and default in the Edit Attribute Definition that displays.
4. Click OK.

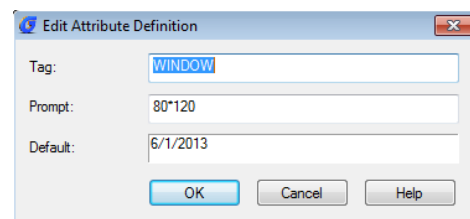

Modify Block Attributes: You can use the Block Attribute Manager to modify attributes in block definitions. For example, you can modify the following items:

- Attributes of blocks can be displayed after modification.
- Text properties that define how attribute text is displayed in the drawing.
- Properties that define the layer that the attribute is on and the attribute line's color, weight, and type

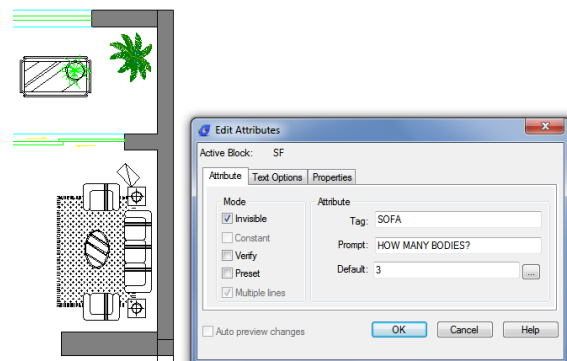

To edit an attribute attached to a block:

1. On the command line, type DDATTE.
2. Select the block to edit. The Edit Attributes dialog box displays all the attributes attached to the block you select.
3. Edit the attribute values as necessary. Then click OK.

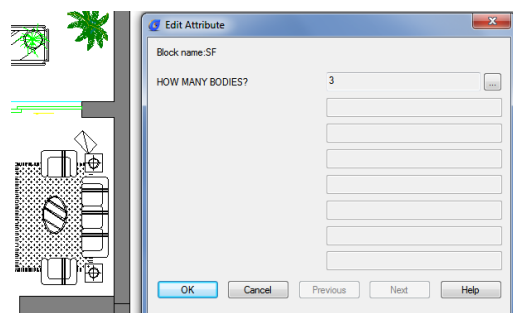

Extract Block Attribute Data: Enter EATTEXT to start Attribute Extraction if the blocks in the drawing contain attributes. You can extract block information according to the wizard prompt and generate list so as to overview the attributes information of the blocks. You can get guide information from the wizard until you accomplish selecting drawings, blocks and block attributes.

With the extract block attribute data function, you can easily create list using drawing data through extracting attribute information and export to external files.

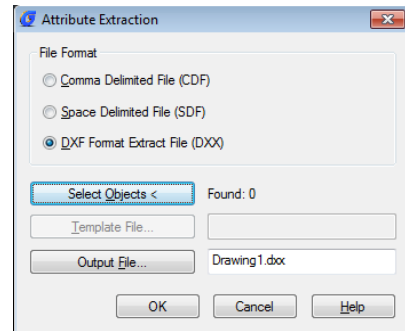

Reference Other Drawing Files (Xrefs)

External references provide additional capabilities not available when you insert a drawing as a block. When you attach an external reference, however, any changes you make to the original drawing file are reflected in the drawings that reference it. External references are useful for assembling master drawings from component drawings. Use external references to coordinate your work with others in a group. External references help reduce the drawing file size and ensure that you are always working with the most recent version of a drawing.

Attach External References: When a drawing is attached to current drawing as external reference, it will be linked to the drawing, any changes to the referenced drawing may affect the external reference in current drawing. External references are inserted into the drawing as block definitions and used as single objects, but you should distinguish the external references and blocks.

To attach an external reference:

1. Choose Insert > External References from the main menu.
2. Click the DWG icon at the top left of the window.
3. In the Select Reference File dialog box, specify the drawing file to attach and then click Open.
4. In the External Reference dialog box, under Reference Type, choose how you want to insert the drawing:
 - Attachment: Inserts a copy of the drawing and includes any other drawings references.
 - Overlay: Lays a copy of a drawing over your original drawing
5. Make any additional selections and then click OK.
6. If you marked Specify On-screen for any items, follow the prompts to attach the external reference.

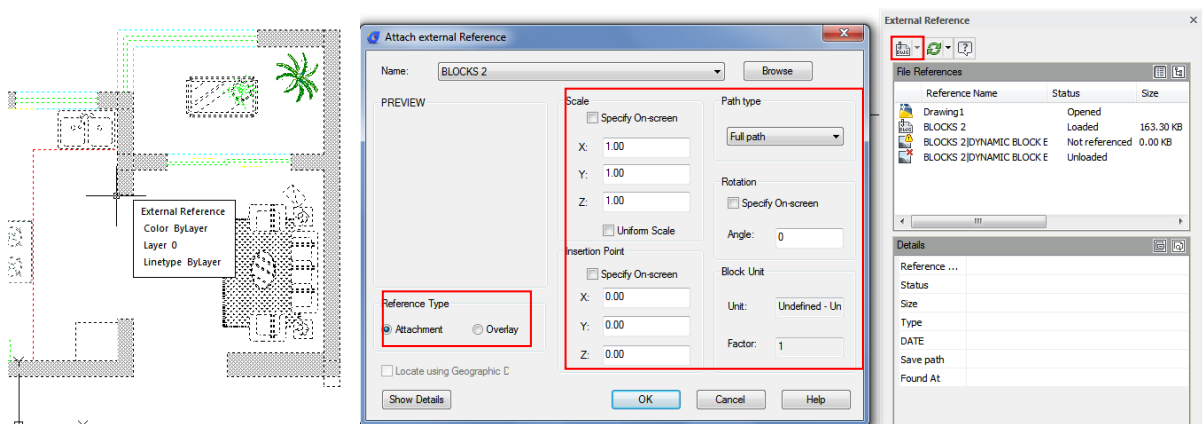

Control the Properties of Referenced Layers:

You can control the visibility, color, linetype, and other properties of an xref's layers and make these changes temporary or permanent. If the VISRETAIN variable is set to 0, these changes apply only to the current drawing session. You can also control the fade display through XDWGFADECTL variable. In addition you can control Xref layer properties directly into the Layer Manager Properties dialog box.

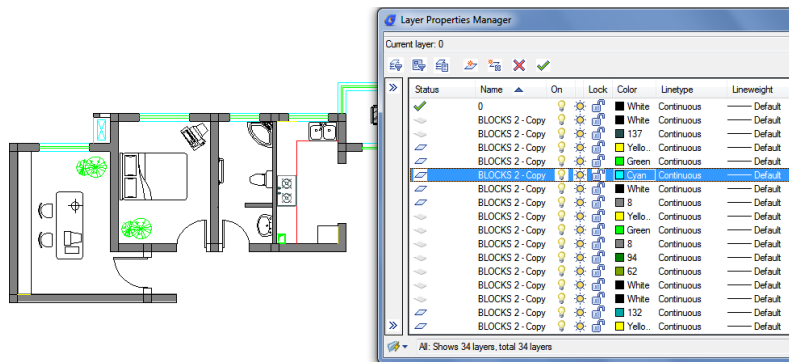

Xref Clipping Boundaries: You can control whether to display clipping boundary of xref through setting system variable XCLIPFRAME. Also you can Clip Xrefs by selecting the option on the menu bar: Modify > Clip > Xref

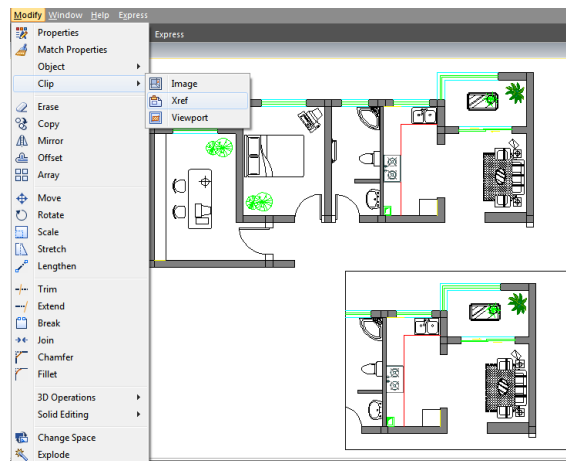

Nest and Overlay External References: Xrefs can be nested in another xref and attached to current drawing. In the process of attaching, you can select insertion position, scaling factor and rotation angle for xrefs.

Binding an Xref to a Drawing: To provide a copy of a drawing containing external references to someone else, you must also provide all the external reference files.

Binding the external references makes them a permanent part of the drawing, which is similar to inserting a separate drawing as a block. You can bind external references by doing right click to the selected Xref file.

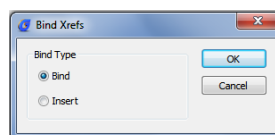

Refresh Xrefs: You can refresh the Xref by clicking the refresh button located at the top of the External Reference Dialog Box.

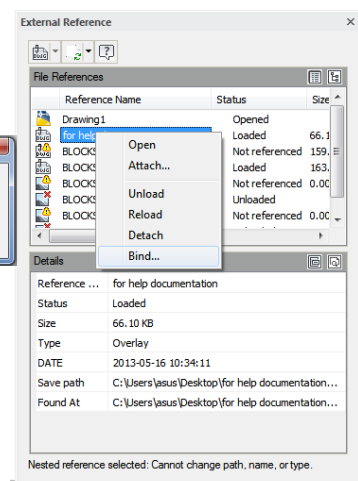

Hatches and Raster Images

Hatches

Define Hatch Boundary: To create a hatch, you should define hatch boundaries first by means of selecting objects to be hatched or picking a point inside the desired object. A hatch boundary can be any combination of objects, such as lines, arcs, circles, and polylines that forms an enclosed area.

Control the Hatching in Islands: You can specify methods of hatching objects in outermost boundary as normal, outer and ignore. Normal is the default hatch pattern, besides, you can view hatching results of different types in the Islands area on Hatch tab of the Hatch and Gradient dialog box.

Normal: Hatch the pattern from the outer boundary to inside. Hatching process will be stopped when encounter inner crossing points, and continue hatching until second inner crossing point appears.

Outer: Hatch from the outer most layer of configuration, and keep the internal blank.

Ignore: Ignore internal objects, only hatches outer objects.

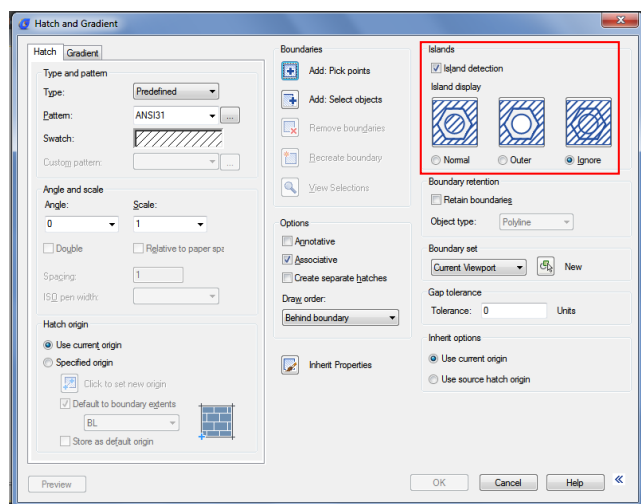

To select objects for hatching:

1. Choose Draw > Hatch from the main menu.
2. From the Hatch and Gradient dialog box, click the Island detection option, and then choose one of the following islands:

Normal, Outer, Ignore:

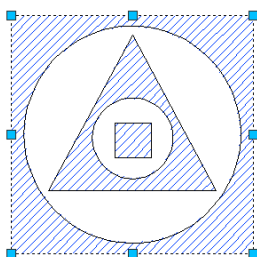

NORMAL ISLAND

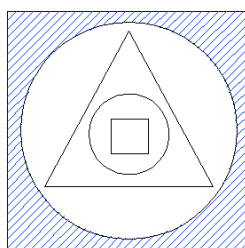

OUTER ISLAND

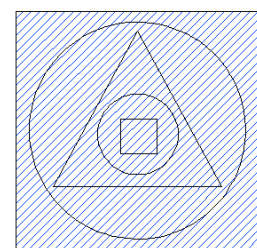

IGNORE ISLAND

3. To keep any new objects that are created for drawing the boundary hatch, select the Retain Boundaries check box under Other options. Existing objects are always retained.
4. In the Boundaries, click Select Objects button.
5. In the drawing, click the objects to be hatched individually, and then press Enter when done.
6. In the Hatch and Gradient dialog box, click OK.

Select an area for hatching:

1. Choose Draw > Hatch from the main menu.
2. From the Hatch and Gradient dialog box, click the Island detection option, and then choose one of the following islands: Normal, Outer or Ignore.

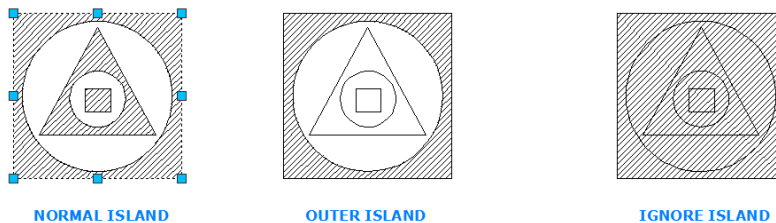

3. To keep any new objects that are created for drawing the boundary hatch, select the Retain Boundaries check box under Other options. Existing objects are always retained.
4. In the Boundaries, click Pick Points button.
5. In the drawing, click inside the closed perimeter of a boundary. If desired, continue clicking inside additional closed perimeters.
6. To complete the selection, press Enter. Then click OK button.

Choose and Define Hatch Patterns: Hatch pattern consists of a repeating pattern of lines, dashes, and dots. You can select a hatch pattern from a set of predefined patterns, or you can define a pattern of your own. The hatch pattern you used most recently is the default pattern the next time you add hatching. The program supplies predefined standard hatch patterns, which are stored in the ICAD.pat and ICADISO.pat hatch pattern library files.

To specify a predefined hatch pattern:

1. Choose Draw > Hatch from the main menu.
2. In the Hatch and Gradient dialog box, click the Hatch tab.
3. Beside Type, click Predefined to apply a scale factor to make the pattern larger or smaller than the default size.
4. Enter the scale factor as a percentage of the default.
5. Enter the angle in degrees (1-360). The default angle is clockwise, you can change the angle of any hatch pattern by entering a numerical value.
6. Enter the ISO pen width. This option is only available if you select existing ISO hatch pattern in the Pattern option.
7. To copy the pattern properties from an existing hatch, choose Inherit Properties.
8. To associate the hatch pattern to its boundary objects, under Other options, select the Associative check box. An associative hatch updates automatically if you move any of its boundaries.
9. To continue, add a hatch by selecting objects or picking points to selected area or boundary you want to hatch.

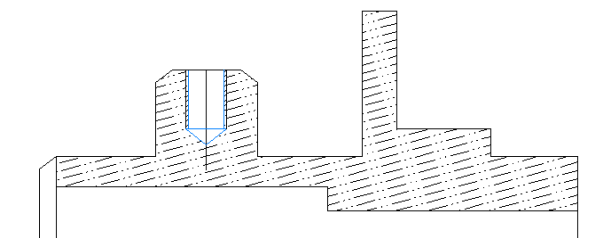
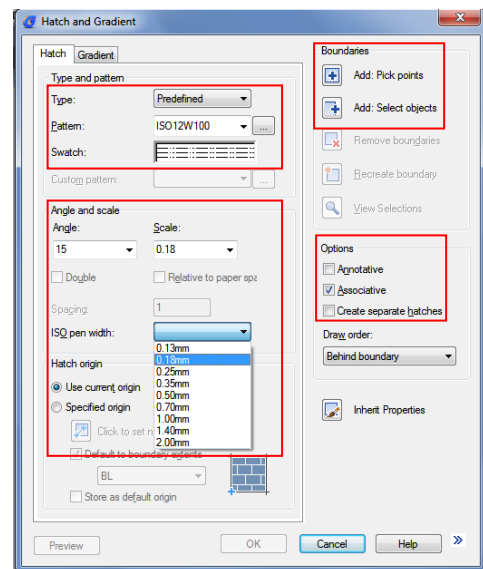

To specify a user-defined hatch pattern:

1. Choose Draw > Hatch from the main menu.
2. From the Hatch and Gradient dialog box, click the Hatch tab.
3. Beside Type, in the Type list, click User Defined.
4. For Spacing, enter the line spacing for the pattern.
5. To copy the pattern properties from an existing hatch, choose Inherit Properties, and select a hatch pattern from a hatched object in the drawing.
6. To associate the hatch pattern to its boundary objects, under Other options, select the Associative check box. An associative hatch updates automatically if you move any of its boundaries.
7. To continue, add a hatch by selecting objects or picking points to selected area or boundary you want to hatch.

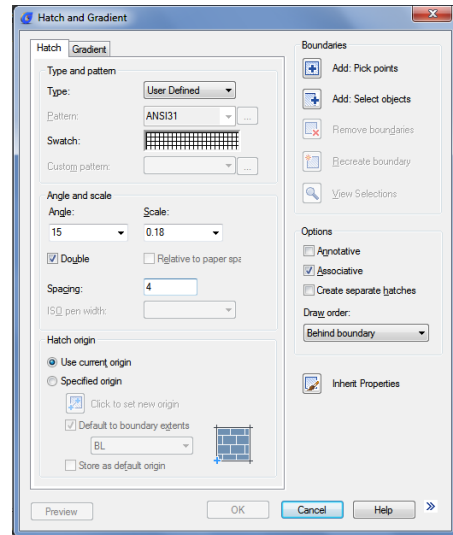

To use a predefined library pattern:

1. Choose Draw > Hatch from the main menu.
2. Click the Hatch tab.
3. Select a Predefined type.
4. To select a predefined pattern, do one of the following:
 - In the Pattern list, click the pattern name.
 - Click the graphical representation of the hatch pattern.
5. To continue, add a hatch by selecting objects or picking points to selected area or boundary you want to hatch.

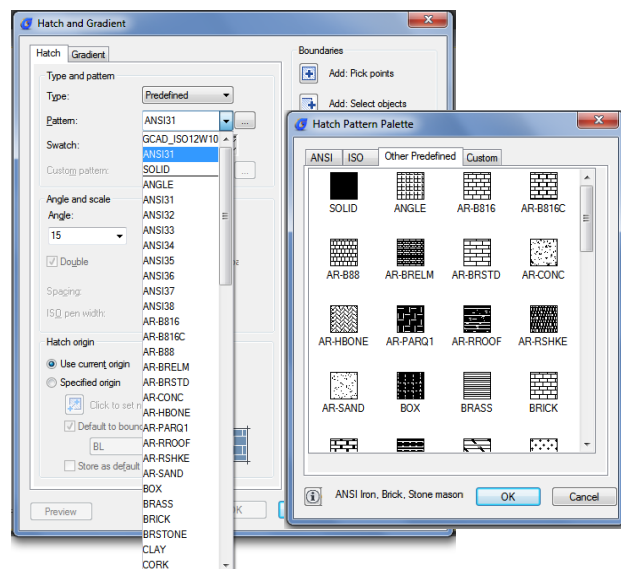

Solid: With the Plane tool, you can draw rectangular, triangular, or quadrilateral areas filled with a solid color. The default method is to specify the corners of the plane. After you specify the first two corners, the plane is displayed as you specify the remaining corners. The program prompts you for the third point and then the fourth point.

To draw a quadrilateral plane:

1. Choose Draw > Modeling > Meshes > 2D Solid
2. Specify the first, second, third and fourth point.
6. Finish the command, press Enter.

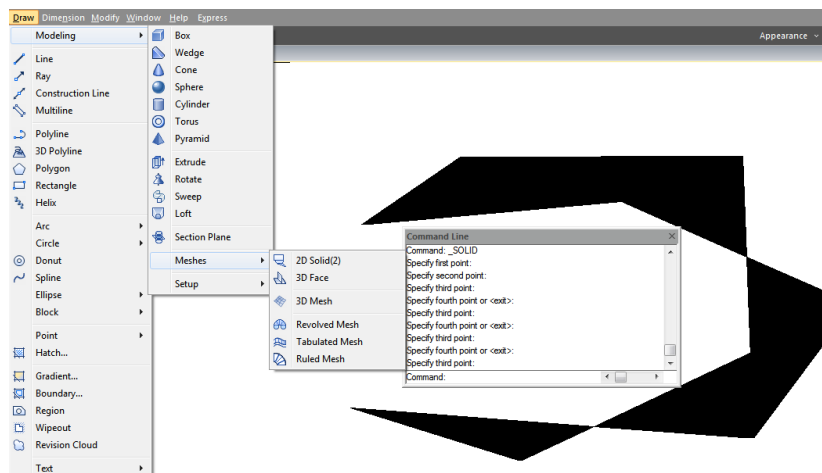

Work with Raster Images

You can view and manipulate raster images and associated file paths in your drawings.

Attach, Scale, and Detach Raster Images:

Raster images consist of a rectangular grid of small squares or dots known as pixels. Raster images can be copied, moved, or clipped as well as a normal object in the drawing. You can also adjust the contrast, transparency, image quality and image frame visibility. Additionally, when inserting raster images, the file format depends on the content of the file rather than the extension name. The following table display all the image file formats supported:

Type:	Description and versions:	Extension:
BMP	Windows and OS/2 bitmap format	.bmp
ECW	Enhanced Compression Wavelet	.ecw
JFIF or JPEG	Joint Photographics Expert Group	.jpg or .jpeg
PCX	Picture PC Paintbrush Picture	.pcx
PNG	Portable Network Graphic	.png
TGA	True Vision Raster-Based Data Format	.tga
TIFF	Tagged Image File Format	.tif or .tiff
GIF	Graphic Interchange Format	.gif

Attach Raster Images: Use IMAGEATTACH command to select and attach raster images, or bitonal, 8-bit gray, 8-bit color, or 24-bit color image files to a drawing. The image file can be inserted as blocks as many times as you like once attached to the current drawing, you can clip the attached raster image and setup its lightness, contrast, fading and transparency.

To attach a raster image:

1. Choose Insert > Raster Image from the main menu.
2. Specify a file to attach, and then click OK.
3. In the Image dialog box, in the Insertion point and Scale, click Specify on-screen. Specify an angle value in Rotation, and then click OK.
4. Specify an insertion point.
5. Specify a scale.

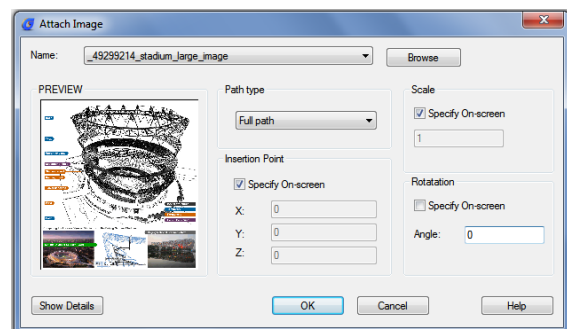

Scale Raster Images: You can specify scale factor in the Image dialog box, otherwise to attach it by its original size. The raster image will be scaled by the specified factor, the scale factor is used without unit by default.

Detach Raster Images: Raster images can be detached if it no longer needs to use in the drawing, a specified image detached from the drawing together with its multiple copies, links and definitions, but the original image file will not be influenced.

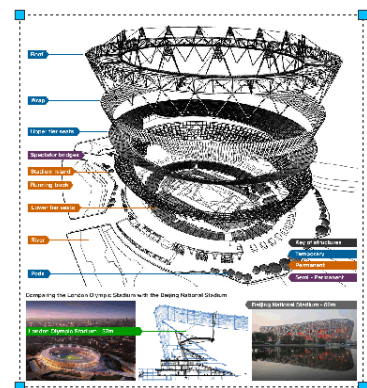

Modify and Manage Raster Images: Controls the properties such as displaying and clipping boundary of raster images. You can view and manipulate attached raster image and change its saving path in Image Manager. Users can turn on/off image boundary in current view using IMAGEFRAME command and setting up the values 0 (off) 1 (on).

To turn image frames on or off for all images:

1. Choose Modify > Object > Image > Frame
2. Do one of the following to toggle frames off and on:
 - Type value 1 to display and print frames for all images in a drawing.
 - Type value 0 to hide all frames on the screen and during printing.

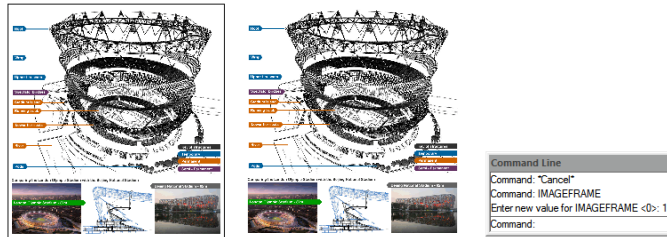

To clip an image in the shape of a rectangle and polygon:

1. Choose Modify > Clip > Image
2. Select the edge of the image you want to clip.
3. Type N (New boundary) to create a new clipping boundary.
4. If you choose Rectangular:
 - Define the first corner of the clipping rectangle.
 - Define the second corner of the clipping rectangle. The selected image is clipped so that only the interior of the rectangle is visible.
5. If you choose Polygon:
 - Select the points for the polygon, and then press Enter when the polygon is complete. The selected image is clipped so only the interior of the polygon is visible.

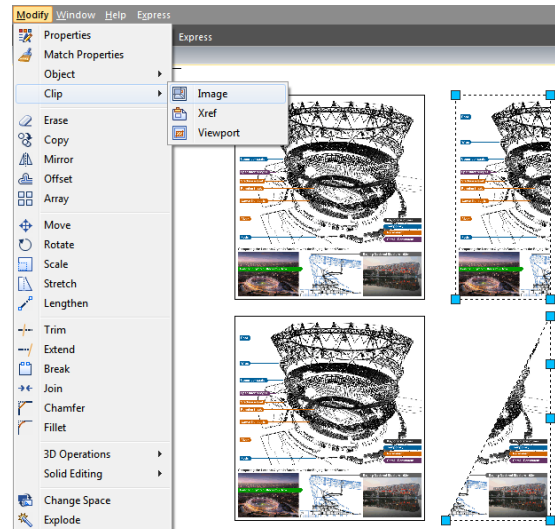

Change Raster Image Brightness, Contrast, and Fade: Use IMAGEADJUST to adjust displaying result and lightness, contrast and fade that are related to the display and plot effect when plotting drawings. IMAGEADJUST does not affect the original raster image as well as other instances of the image.

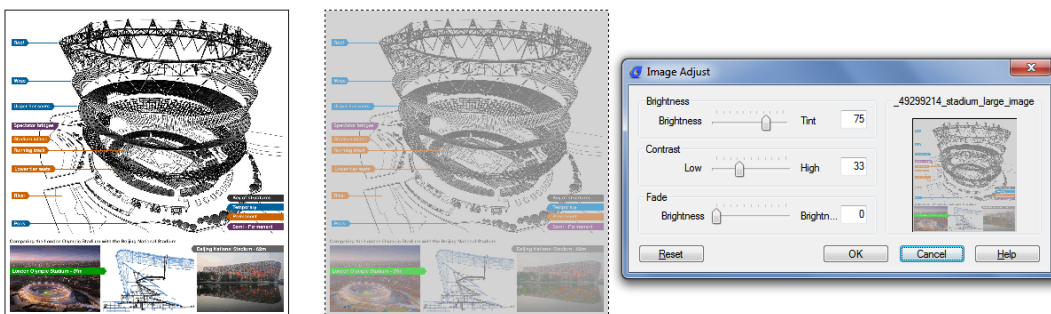

Improve the Display Speed of Raster Images: You can adjust the display speed by setting the raster image quality. The image quality is sorted into high and draft levels, If the quality is set to draft, the image will be displayed with some granular materials, however with faster display speed.

Layout, Plot and Publish Drawings

Create Multiple-View Drawing Layouts

Overview of Layout: A layout represents a plotted page on which one or more model views are displayed. GstarCAD provides two collateral working environments as Model and Layout tab. You can create thematic models on Model tab. Multiple slides of the model can be set in Layout tab. Use these general steps to prepare your drawing for printing multiple layouts:

1. On the Model tab, create your drawing.
2. Create a new layout. You can use an existing Layout1 or Layout2 tab, or you can create a new Layout tab.
3. Create at least one layout viewport on the Layout tab. Use each viewport to help control which portion of the drawing prints and at what scale.
4. Specify additional settings for the layout, such as the scale of the drawing, print area, print style tables, and more.
5. Print or plot your drawing.

You can right click on Layout tab and select "New layout" to create a new layout, and also import layout from template. Options on Shortcut menu are listed:

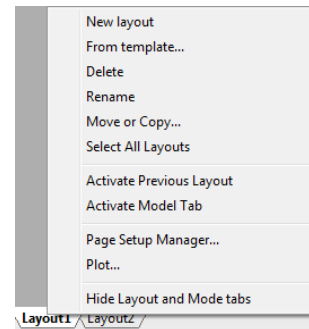

Work with Model Space and Paper Space: Model space is generally used for creating and editing drawings. Preparations for plotting are usually working on paper space for the drawings on layouts are close to the plotting effects.

Model space is an area in which you create two dimensional and three dimensional objects based on either the World Coordinate System (WCS) or a user coordinate system (UCS). The contents of paper space represent the paper layout of your drawing. In this work area, you can create and arrange different views of your model similar to the way you arrange detail drawings or orthogonal views of a model on a sheet of paper.

Layout tab is enabled to make relevant plot settings. Paper space is provided in each layout option, and you are allowed to create viewports and specify page setup such as paper size, orientation and location that can be saved together with the layout.

You can save and name the page setup and apply it to other layouts when setting pages. You can also create new layouts using existing layout template file (DWT or DWG).

Click on the Model tab, you can view and edit objects in model space.

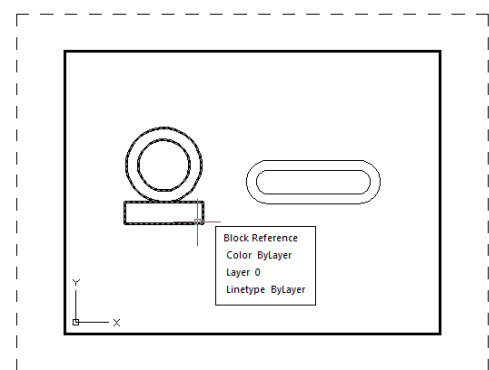
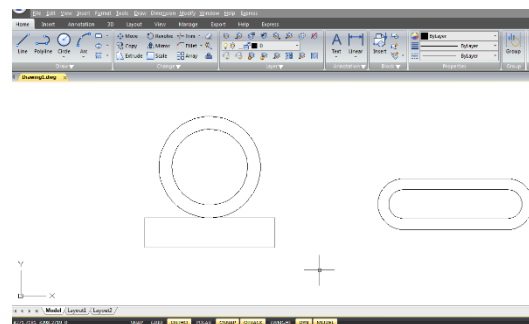

Specify Layout Settings: Once created a drawing in Model tab, you can toggle to Layout tab and setup the layout for plotting, such as paper size, drawing orientation and so on. You can right click on the Layout tab to create new layouts or import from template files, and then click Modify button on the Page Setup Manager dialog box to set the page.

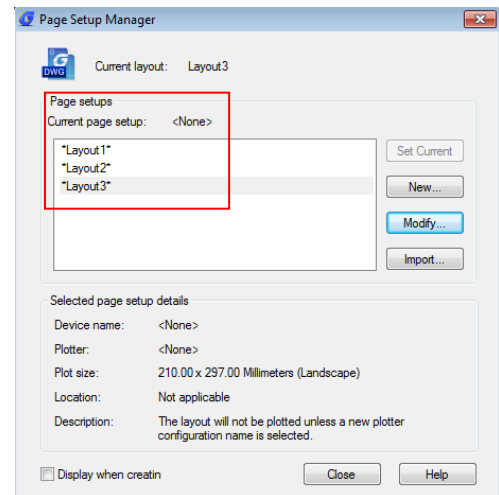

Select a Paper Size for a Layout: The paper size here refers to the size of the drawing. When you start Plot dialog box in Layout tab, you can assign the paper type from pull down list of the Paper Size text box. The Paper size is directly previewed from the sketch with its size and units. The available paper types provided in the pull down list are decided by the current configuration. If you want to configure plotters to export raster images, you must specify output size by pixels. The paper size can be customized in the Plotter Configuration Editor.

Determine the Drawing Orientation of a Layout:

The drawing orientation is sorted into Landscape and Portrait, which decide the plotting orientation of the drawing to be seen on a paper. Once specified the drawing orientation, you can control whether to plot the top or the bottom of the drawing by selecting Plot Upsize-down option. The changes setup in Page Setup dialog box are still saved in layouts. Certain page settings can be replaced by customized plot settings, but the settings will not be saved in the layout unless you click Apply to Layout option.

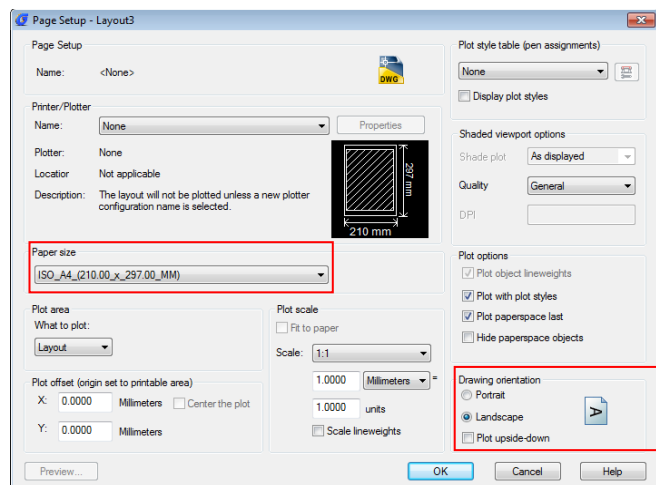

Adjust the Plot Offset of a Layout: You can offset the geometry on the paper by entering a positive or negative value in the X and Y Offset boxes. Changing the plotting origin may change the position of drawing on papers. The plot origin locates at the left lower corner of plotting area with offset value of 0 relative to X and Y direction. Select Center on Paper if the specified plot area is part of the drawing rather than the whole layout, which changes the position of plot origin.

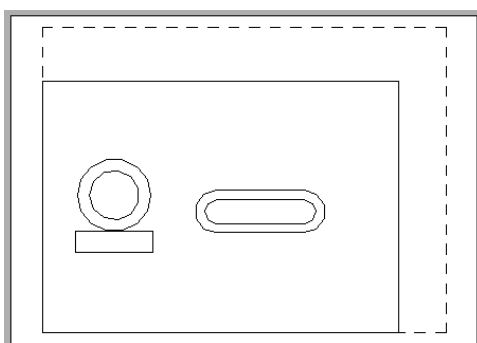

Plot with origin (0,0)

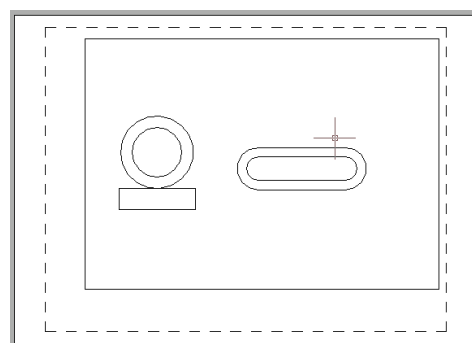

Plot with origin (10,10)

Set the Plot Area of a Layout: You can set the area to be plotted in Plot dialog box. When creating new layouts, the default plot option is drawing limits which means plotting all the objects within the drawing paper. The plot origin is (0,0), located at the left lower corner of the page. Do the following methods to select a plot area:

- Layout:** Plots all the objects within the drawing paper.
- Window:** Set the Plot Scale for a Layout, Plots any portion of the drawing you specify within the rectangle window. Click the Window button to use a pointing device to specify opposite corners of the area to be plotted, and then return to the Plot dialog box.
- Extents:** Plots the portion of the current space of the drawing that contains objects.
- Display:** Plots the contents displayed in current view.

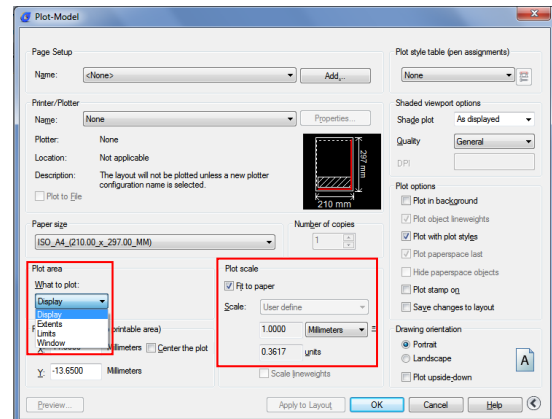

Set the Plot and Lineweight Scale for a Layout: When you specify a scale to output your drawing, you can choose Fit to Paper to scale the drawing to fit onto the selected paper size. Usually, the objects in model space are displayed at the scale set in layout viewports. To plot the objects in model space with the scale specified in layouts, you assign the scale to 1:1. Even if plot scale of layouts is assigned, it's enabled to scale the lineweight at a certain scale. Scaling the lineweight is nothing to do with the plot scale when plotting drawings, which is mainly used for the lines included in the objects to be plotted.

Move and Copy Layouts: You can right click on the Layout tab to select Move or Copy option, on the Move or Copy dialog box, you can select a layout which you want to place after the current layout. To Create a Copy of current layout, you can select a layout and check Create a Copy, the copied layout will place before the layout you selected. You should notice that Model tab can't be moved or copied.

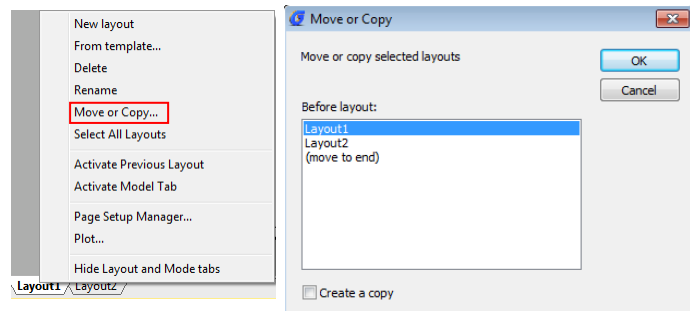

Create Layout from Template: Right click on the Layout tab to select from template option to import DWG or DWT file directly, using information of existing template to create new layouts. System provides template file with extension name as .dwt. Layout templates from any drawing templates can be imported into the current drawing.

To create a new layout from an existing file:

1. Choose Insert>Layout>Layout from Template

2. In the dialog box, select the desired template file, and then click Open.

In the Insert Layout(s) dialog box, select the layout(s) you want to insert, and then click

OK. You can choose multiple layouts by holding down Ctrl while selecting layout names.

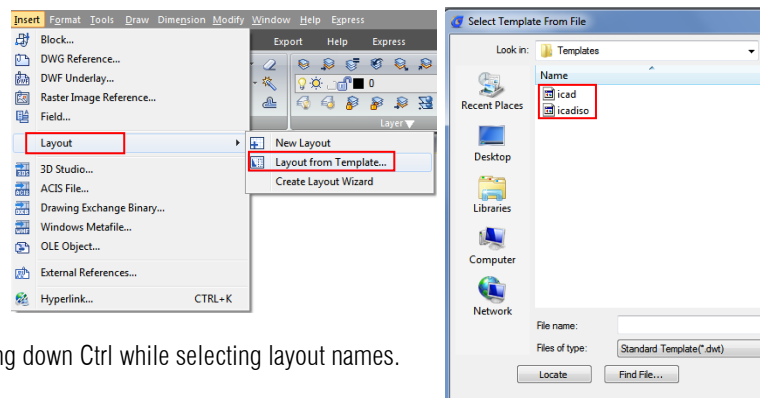

Create and Modify Layout Viewports: On a Layout tab, you must create at least one layout viewport to see your model. Each layout viewport is created as a separate entity that you can move, copy, or delete. Any changes you make in one layout viewport are immediately visible in the other viewports (if the other layout viewports are displaying that portion of the drawing). Zooming or panning in the current viewport affects only that viewport.

Create layout viewports:

1. On the command line, type MVIEW.
2. Type F (Fit), or create 2, 3 or 4 viewports by entering 2, 3 or 4 separately, or specify two opposing corners to create a custom viewport.
3. Choose the viewport arrangement, typing H (Horizontal) or V (Vertical).
4. Do one of the following:
 - To arrange the viewports to fill the current graphic area, type F (Fit).
 - To fit the viewports within a bounding rectangle, specify the corners of a rectangle.

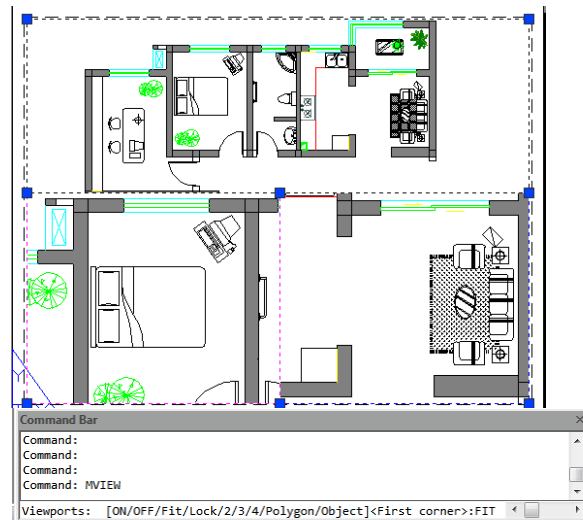

You can create a single layout viewport, or you can divide the graphic area into many viewports arranged [Horizontal/Vertical/Above/Below/Left/Right].

To modify layout viewport properties:

1. Click the border of the layout viewport whose properties you want to modify.
2. Open the Properties palette through the menu option "Tools > Palettes > Properties" or "Modify > Properties".
3. In the Properties palette, select Standard Scale, and then select a new scale from the list. The scale you choose is applied to the viewport.

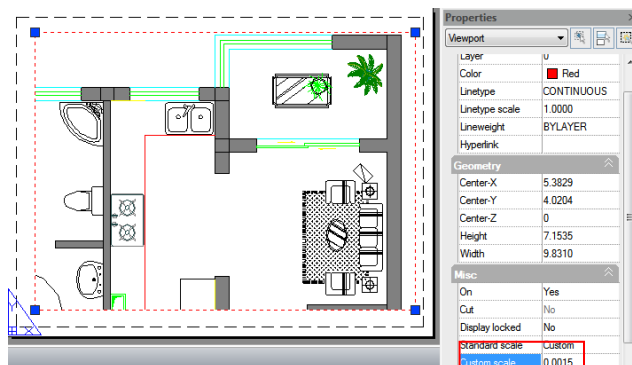

Turn Layout Viewports On or Off:

1. Click the desired Layout tab.
2. Type MVIEW and then press Enter.
3. Type ON or OFF.
4. Select the edge of the layout viewport to turn on or off, then press Enter.

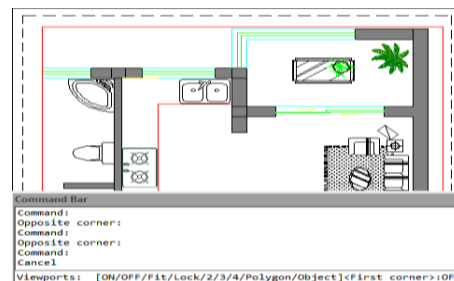

Create Non-rectangular layout viewports:

Use Object and Polygonal options of MVIEW to create irregular viewports, Select Object option to convert objects created in paper space to viewports. While selecting Polygonal option to draw irregular polylines including arcs and lines which are enabled to either intersect or three vertexes at least, the polyline will be closed automatically.

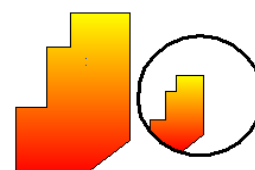

Plot Drawings

When a drawing is completed, you can output it using several methods. You can plot the drawing on paper or create a file for use with another application.

Plot Settings: When you create a drawing, you do most of your work on the Model tab. At any time you can print your drawing to see how it looks on paper. It's easy to startup printing, and then later create layouts and custom print settings to enhance your printed output.

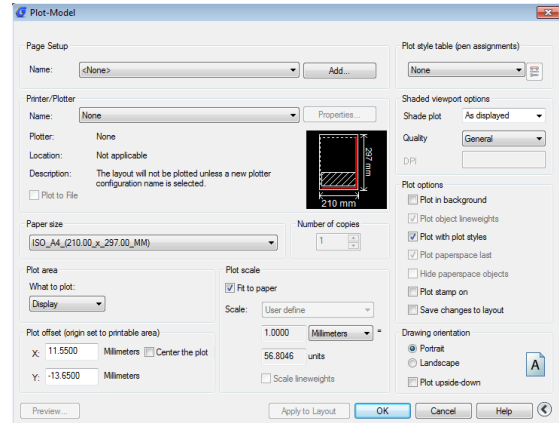

To start printing:

1. Choose File > Plot from the main menu.
2. Set the printer and relevant parameters, and then click OK.

Set Paper Size: You can assign the paper type from pull down list of the Paper Size text box. If you want to setup paper size, you should configure plotters first, all the available plotters are both system plotters of Windows configured and non-system driven.

To select a printer or plotter:

1. Choose File > Plot from the main menu.
2. From the Name list in Printer/Plotter area, select a printer or plotter you want to use, and then click OK.

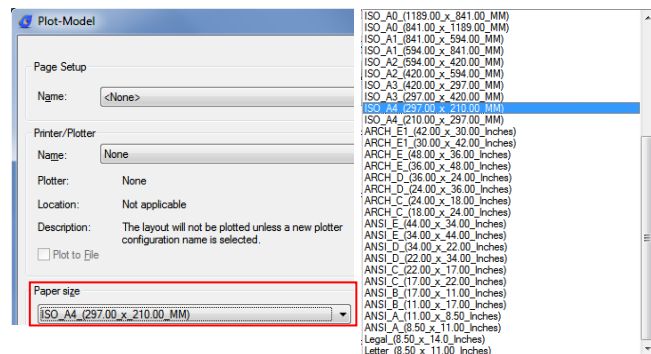

Position the Drawing on the Paper: You can adjust the position of the drawing to be plotted on a paper before plotting.

To specify the print area origin:

1. If necessary, click the desired Layout tab or the Model tab.
2. Choose File > Plot from the main menu.
3. Do one of the following in the Plot Offset area:
 - To center the specified print area on the printed page, select Center the Plot check box.
 - To specify an origin for the print area, type the X and Y coordinates.
4. Select OK, and then click Apply to Layout.

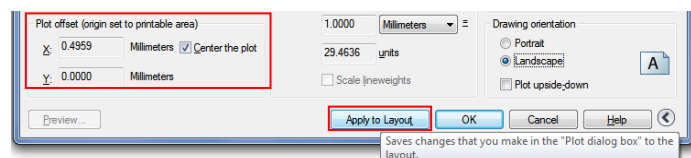

Set Drawing Orientation: The drawing orientation determines whether to plot a drawing portrait or landscape. If you select Landscape, plots the drawing using the length edge as horizontal. While selecting Portrait to plot the drawing using its minor edge as horizontal. Changing the drawing orientation just like rotating the paper under the drawing. Meanwhile, selecting Plot upside-down to control whether to locate the drawing upside-down on paper.

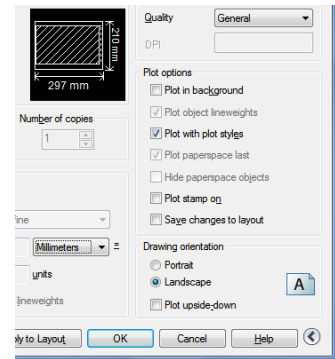

Set Plot Scale: Plot scale of the drawing can be specified directly from the Scale pull-down list in Plot Scale area of Plot dialog box. You can also choose User define to set desired plot scale, or choose Fit to Paper to scale the drawing to fit onto the selected paper size. The plot scale together with plot unit and drawing unit must be specified before plotting. For example, if you select the paper size to mm, entering 1 under mm and 10 under Units blank produces a plotted drawing with each plotted unit represents 10 actual millimeters.

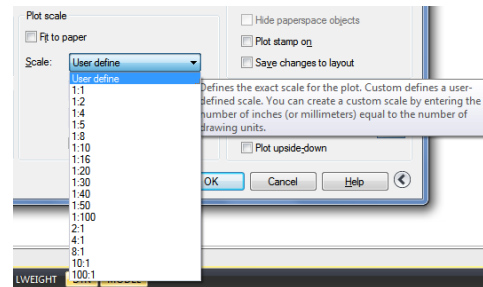

To automatically scale the drawing for printing:

1. If necessary, click the desired Layout tab or the Model tab.
2. Choose File > Plot from the main menu.
3. To scale the drawing to fit on one printed page, in Plot Scale, click Fit to Paper.
4. Select Apply to Layout and click OK.

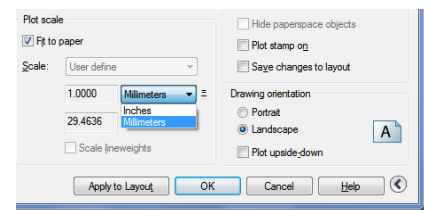

Set Plot Options: The following options show plot patterns with instructions on how to plot objects.

- Plot in Background.** Specifies that the plot is processed in background.
- Plot Object Lineweights.** Specifies that lineweights assigned to objects and layers are plotted.
- Plot with Plot Styles.** Plots a drawing with specified plot styles. Plots lineweights automatically once selecting this option automatically. If you do not select this option, objects are plotted with their assigned properties and not with the plot style overrides.
- Plot Paperspace Last.** Plots model space geometry first. Paper space geometry is usually plotted before model space geometry.
- Hide Paperspace Objects.** Suppresses the plotting of objects that are located behind other objects regardless of how it's displayed on screen. This option is only available in the Layout tabs.
- Plot Stamp on.** Horizontally or vertically placed the plot stamp information on a specified corner of drawing. The plot stamp settings can be saved to log file, also cannot be saved.
- Save Changes to Layout.** All the changes you make in the Plot dialog box will be saved to the layout if you click OK.

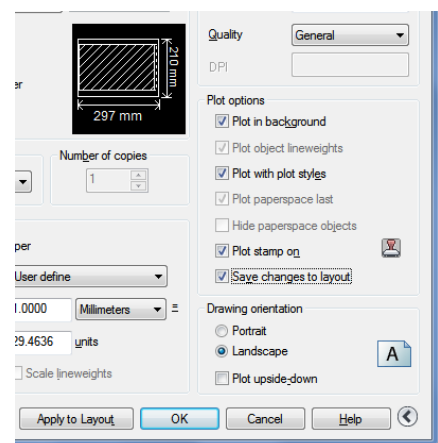

Specify the Area to Plot: To specify a portion of the drawing to print, if necessary, click the desired Layout tab or the Model tab.

1. Choose File > Plot from the main menu.
2. Under Print Area, click one of the following:
 - Display** – Plots the current view on the screen.
 - Extents** – Plots the contents within the specified drawing extents.
 - Limits/Layout** – Plots the contents within the specified drawing limits or entities in the printable area.
 - Window** – Plots the portion of the drawing contained in the specified window. Click the Window button to use a pointing device to specify opposite corners of the area to be plotted, and then return to the Plot dialog box.
3. Select Apply to Layout and click OK.

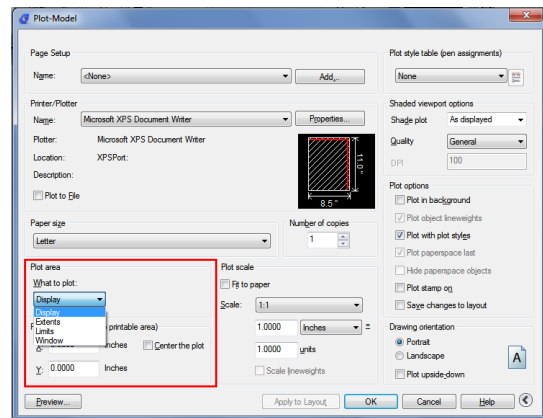

Preview a Plot: Viewing a drawing before printing gives you a preview of what your drawing will look like when it is printed.

To preview a drawing before printing:

1. If necessary, click the desired Layout tab or the Model tab.
2. Choose File > Plot Preview from the main menu.
3. Do one of the following:
 - To print the drawing, click preview and click Plot on the top left corner of print preview.
 - To return to the drawing, click the off button or press Esc.

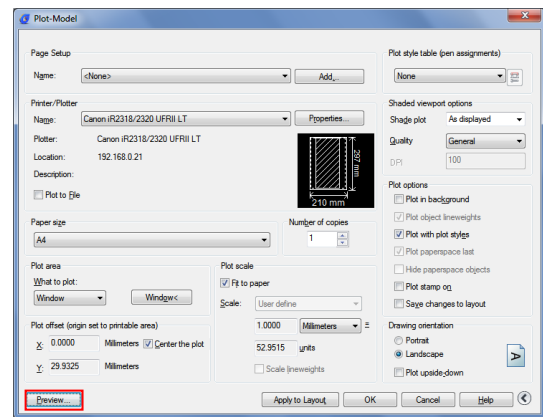

Use Plot Styles: Plot styles help you control what your drawing looks like when it is printed. Because plot styles are saved in plot style tables, which are files located on your computer, you can reuse them to help eliminate the need to reconfigure your print settings each time you print a drawing. A drawing can use one type of plot style table at a time. There are two types of plot style tables:

- Color-dependent plot style tables (CTB)** contain a collection of plot styles based on each of the 255 index colors available in a drawing.
- Named plot style tables (STB)** contain a collection of plot styles that you define. They can vary regardless of color.

To assign plot style tables:

1. If necessary, click the desired Layout tab, or click the Model tab.
2. Choose File > Plot from the main menu.
3. Under Plot Style Table (pen assignments), select a plot style table in the one of the following:
 - None:** Applies no plot style table. Objects plot according to their own properties.
 - Monochrome:** Plots all colors as black.
 - New:** Creates a new plot style table.
4. Select Save Changes to Layout, and then click Apply to Layout.

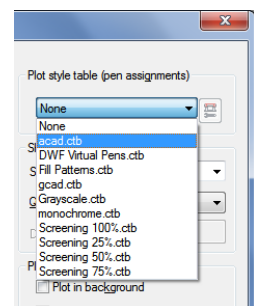

To Modify plot style tables:

1. Choose File > Plot from the main menu.
2. Under Plot Style Table (pen assignments), click the plot style table you want to modify, and then click the button to display "Plot Style Table Editor".
3. Click the General tab on Plot Style Table Editor, and then do any of the following:
 - Enter a new plot style description.
 - Select Apply global scale factor to non-ISO linetypes to apply the scale factor
 - Enter a scale factor to apply to non-ISO linetypes used for any plot style in the current plot style table.

4. Click the Form View tab, and then do any of the following:
 - Make changes to a color-dependent plot style by selecting it in the Plot list, and then make color, linetype, or lineweight changes for the plot style in Properties area. Your changes are saved automatically for the selected plot style.
 - Make changes to a named plot style by selecting it in the Plot list, and then make color, linetype, or lineweight changes for the plot style in Properties area. Your changes are saved automatically for the selected plot style.
 - Add a new plot style by clicking Add Style. Enter a new name, and then click OK. Select the options for the plot style. (Available for named plot styles only.)
 - Delete a plot style by selecting it in the Plot list, and then click Delete Style. (Available for named plot styles only.)

5. Click OK.

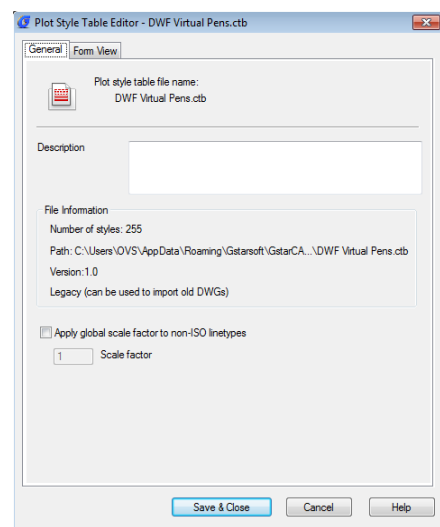
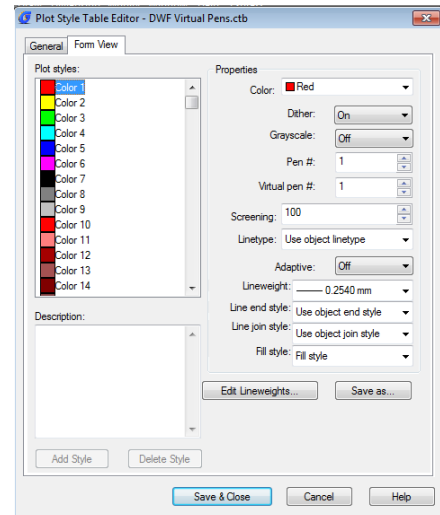

Plot Files to Other Formats: Plot files have various formats. You can output drawings in any image formats with unique plotter driver.

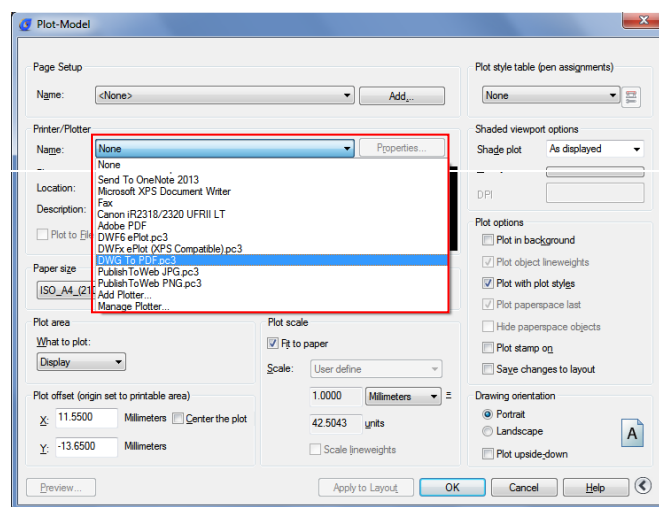

Publish Drawings: Specifies drawing sheets that you can assemble, reorder, rename, copy, and save for publishing as a multi-sheet drawing set. You can publish the drawing set to a DWF, DWFx, or PDF file or send it to the plotter named in the page setup for hardcopy output or as a plot file. The following options are displayed in the Publish Dialog Box:

1. **Load Sheet List Button:** Displays the Load Sheet List dialog box, in which you can select a DSD file or a BP3 (Batch Plot) file to load.
2. **Save Sheet List Button:** Displays the Save List As dialog box, in which you can save the current list of drawings as a DSD file.
3. **Sheet List:** Displays the current drawing set (DSD) or batch plot (BP3) file.
4. **Publish to:** Defines how to publish the list of sheets. You can publish to either a multi-sheet DWF, DWFx, or PDF file.
5. **Automatically load all open drawings:** When selected, the contents of all open documents are automatically loaded in the publish list.
6. **Add Sheets Button:** Displays the Select Drawings dialog box, in which you can select drawings to add to the list of drawing sheets.
7. **Remove Sheets Button:** Deletes the selected drawing sheets from the list of sheets.
8. **Move Sheet Up Button:** Moves the selected drawing sheets up one position in the list.
9. **Move Sheet Down Button:** Moves the selected drawing sheets down one position in the list.
10. **Preview Button:** Displays the drawing as it will appear when plotted on paper by executing the PREVIEW command.
11. **Sheet Name:** Combines the

drawing name and the layout name with a dash (-).

12. **Page Setup/3D DWF:** Displays the named page setup for the sheet. You can change the page setup by clicking the page setup name and selecting another page setup from the list

13. **Status:** Displays the status of the sheet when it is loaded to the list of sheets.

14/15. **Show and select sheet details:** Displays and hides the Selected Sheet Information and Selected Page Setup Information areas.

16. **Publish Options:** Opens the Publish Options dialog box, in which you can specify options for publishing.

17. **Number of Copies:** Specifies the number of copies to publish.

18. **Precision:** Optimizes the dpi of DWF, DWFx, and PDF files for your field: manufacturing, architecture or

civil engineering.

19. **Include Plot Stamp:** Places a plot stamp on a specified corner of each drawing and logs it to a file.

20. **Plot Stamp Settings:** Displays the Plot Stamp Dialog Box/Plot Stamp Settings Dialog Box, in which you can specify the information, such as drawing name and plot scale that you want applied to the plot stamp.

21. **Publish in Background:** Toggles background publishing for the selected sheets.

22. **Send the Sheets to the Plotter in Reverse Order:** When selected, sends sheets to the plotter in reverse of default order. This option is available only if the Plotter Named in Page Setup option is selected.

23. **Open in Viewer when Done:** When publishing completes, the DWF, DWFx or PDF file will open in a viewer application.

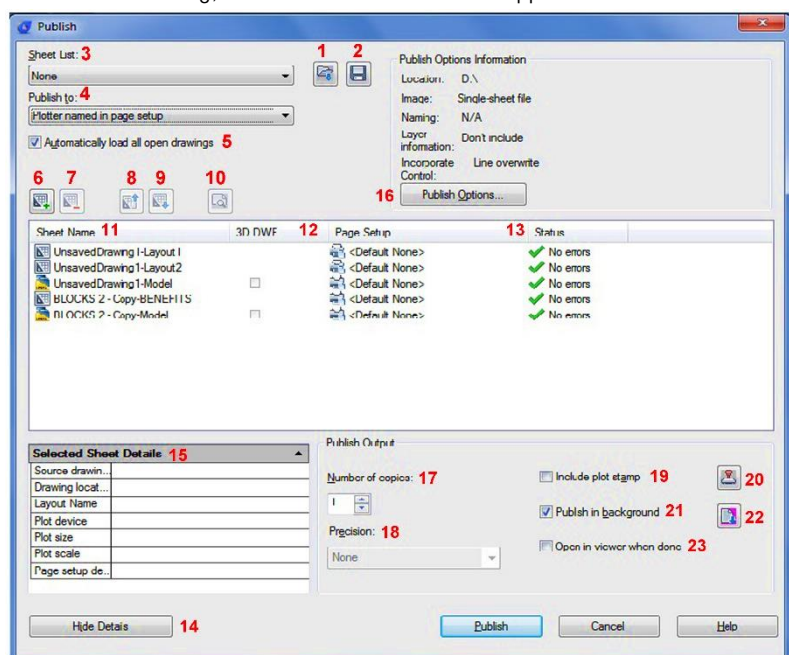

Create and Edit Dynamic Blocks

In GstarCAD8, you can create and edit Dynamic Blocks. Dynamic block references contain grips or custom properties that change the way the reference is displayed in the drawing after it is inserted. Dynamic blocks allow you to insert one block that can change shape, size, or configuration, instead of inserting one of many static block definitions.

Some dynamic blocks are defined so that geometry within the block can only be edited to certain sizes specified in the block definition. When you use a grip to edit the block reference, tick marks are displayed at the locations of valid values for the block reference. If you change a block property value to a value other than one specified in the definition, the parameter will adjust to the closest valid value.

Dynamic Block Editor: You can access the Block Editor by typing the edit command or by double-clicking the block without attribute. The Block Editor ribbon interface will show as below, the black arrows mark the stand for parameters, while the yellow lighting is the symbol for action. It will pop-up toolbars in a classic interface.

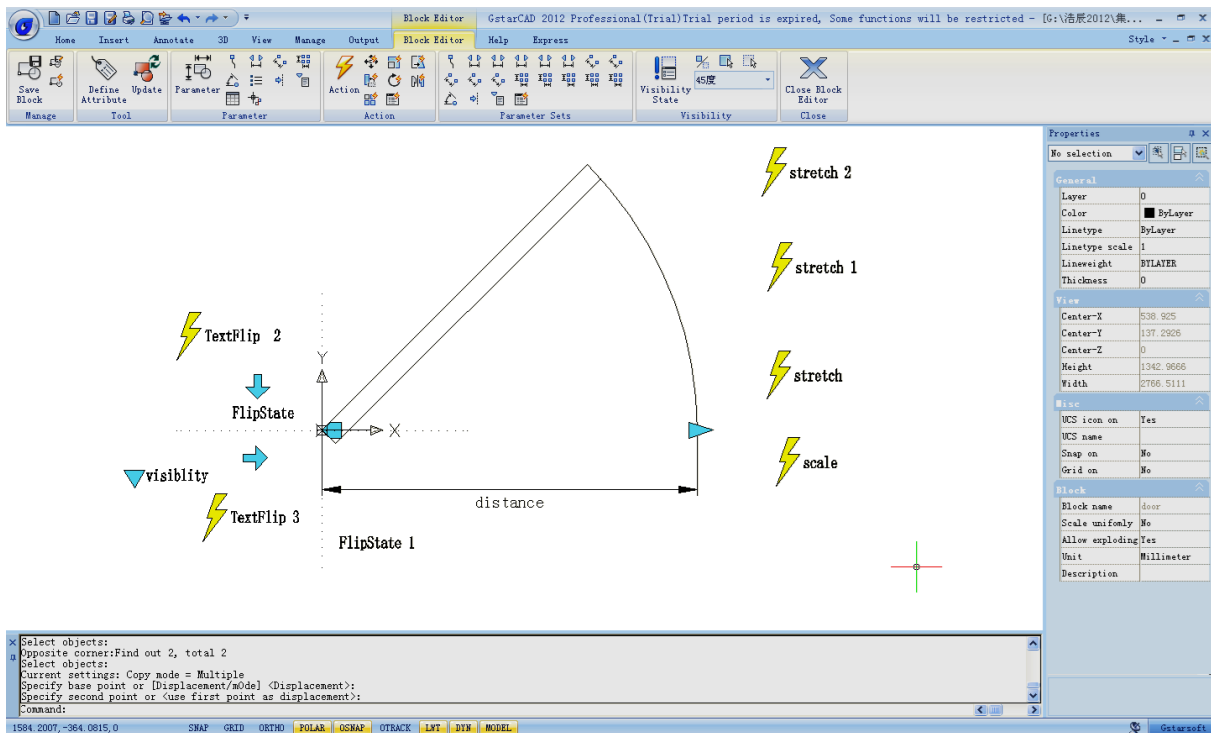

Dynamic Block Editor Tool Panels: Using the tools in this Tool Panel to define, edit and modify dynamic blocks definitions , makes it very convenient and fast.

Manage

Save or Save as the default block; Create or edit another block.



Tool

Define, edit or update the block attribute.

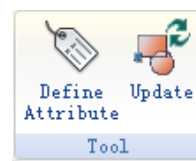

Parameter

You can add parameters for Dynamic Blocks on this panel.

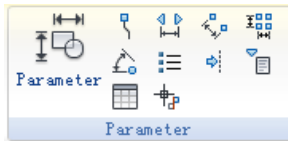

Visibility

This panel is specially used for Visibility editing.



Action

You can add actions for Dynamic Blocks on this panel.



Close

It is used to exit the Block Editor. Before exiting, some commands like save or open etc. might not work.



Parameter Sets

You can add the parameter set on this panel.

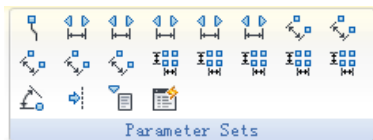

Parameters: Define custom properties for the dynamic block by specifying positions, distances, and angles for geometry in the block. You add parameters to a dynamic block definition in the Block Editor. In the Block Editor, parameters have an appearance similar to dimensions. Parameters define custom properties for the block. Parameters also specify positions, distances, and angles for geometry in the block reference. When you add a parameter to a dynamic block definition, the parameter defines one or more custom properties for the block.

A dynamic block definition must contain at least one parameter. When a parameter is added to a dynamic block definition, grips associated with key points of the parameter are automatically added. You must then add an action to the block definition and associate the action with a parameter.

Parameters also define and constrain values that affect the dynamic block reference's behavior in a drawing. Some parameters can have a fixed set of values, minimum and maximum values, or increment values. For example, a linear parameter used in a window block may have the following fixed set of values: 10, 20, 30, and 40. When the block reference is inserted in a drawing, you can only change the window to one of these values. Adding a value set to a parameter allows you to limit how the block reference is manipulated in a drawing.

Point Parameter

Icon:

Command: BParameter→O

Defines an X and Y location in the drawing. A point parameter can be associated with a move or stretch action.

Linear Parameter

Icon:

Command: BParameter→L

Shows the distance between two anchor points. Constrains grip movement along a preset angle. A linear parameter can be associated with a move, stretch, scale or array action.

Polar Parameter

Command: BParameter→P

Shows the distance between two anchor points and displays an angle value. You can use both grips and the Properties palette to change both the distance value and the angle. A polar parameter can be associated with a move, scale, stretch, polar stretch, or array action.

XY Parameter

Command: BParameter→X

Shows the X and Y distances from the base point of the parameter. It can be associated with a move, scale, stretch, or array action.

Rotation Parameter

Command: BParameter→R

Defines an angle. The rotation angle can be in any value, or be defined in a range or a specified value.

Alignment Parameter

Command: BParameter→A

Defines an X and Y location and an angle. An alignment parameter always applies to the entire block and needs no action associated with it. An alignment parameter allows the block reference to automatically rotate around a point to align with another object in the drawing. An alignment parameter affects the rotation property of the block.

Flip Parameter

Command: BParameter→F

A flip parameter flips objects. You can associate a flip parameter with a flip action.

Visibility Parameter

Command: BParameter→V

Controls the visibility of objects in the block. A visibility parameter always applies to the entire block and needs no action associated with it. In a drawing, you click the grip to display a list of visibility states available for the block reference.

Lookup Parameter

Command: BParameter→K

Defines a custom property that you can specify or set to evaluate a value from a list or table you define. It can be associated with a single lookup grip. In the block reference, you click the grip to display a list of available values. You can associate a lookup parameter with a lookup action.

Base Point Parameter

Command: BParameter→B

Defines a base point for the dynamic block reference relative to the geometry in the block. Cannot be associated with any actions, but can belong to an action's selection set.

Actions: Actions define how the geometry of a dynamic block reference will move or change when the custom properties of the block reference are manipulated in a drawing.

Move

Command: BActionTool→M

A move action causes objects to move a specified distance and angle such as a point, a linear, a polar, an XY parameter, etc, moves all objects in a selection set in a/any direction.

Scale

Command: BActionTool→S

A scale action such as a linear, a polar, an XY parameter, and so on, scales the selected objects in the direction of the parameter. Users can manipulate the grips in different way by changing the properties and values in the Properties palette.

Stretch

Command: BActionTool→T

A stretch action causes objects to move and stretch a specified distance in a specified location. A stretch action associated with a point, a linear, a polar, an XY parameter, etc.

Polar Stretch

Command: BParameter→PIn

A polar stretch action rotates, moves, and stretches objects a

specified angle and distance when the key point on the associated polar parameter is changed through a grip or the Properties palette. A polar stretch action can only be applied to a polar parameter.

Rotate

Command: BActionTool→P

A rotate action is always associated with a rotate parameter. Selected objects can be rotated freely, or the way the grips are manipulated is different in the Properties palette.

Flip

Command: BActionTool→F

A flip action is always associated with a flip parameter.

Array

Command: BActionTool→A

An array action is associated with a linear, a polar, an XY parameter, etc, copies and arrays selected objects in different way.

Lookup

Command: BActionTool→L

A lookup action can only be associated with a lookup parameter.

The General Steps of Creating a Dynamic Block Definition: In order to get a Dynamic Block Definition, improve block editing efficiency and avoid repeating modifications, we can create Dynamic Block by the following steps.

Step1: Planning

Before creating Dynamic Block, it is essential to plan Dynamic Block, plan the functions, appearance, the method of drawing and required Parameter(s) and Action(s) which are needed to achieve prospective functions.

Step2: Draw geometric figure

The included basic pixel during Dynamic drawing, of course, you can draw these pixel in Block Editor.

Step3: Add Parameter and Action

This is the most pivotal step when creating Dynamic Block. When editing the Parameter and Action, you not only consider the achievement of Parameter and Action, but also consider the readability of Dynamic Block and the convenience of Modification, let the action point of the Parameter attach on the corresponding pixel as far as possible, and put the Action near to its relevant

parameter, if there are more Parameters and Actions, they still need to be renamed for understanding, editing and Modification.

Step4: Test Dynamic Block

Save and Exit Block Editor, start the Dynamic Block test to check if it reaches to the prospective effect.

Dynamic Blocks Creation Samples

See what you are able to do within the Dynamic Block Editor, and get the most out of your design. See the follow samples:

Base Point Parameter: Although the majority of parameters only taken into effect when operations are matched with actions, there are exceptions, base point parameter is one of them.

1. **Define blocks:** Define block and draw a circle in the block editor, as shown.

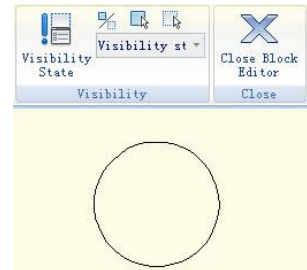

2. **Add base point:** Click "base point" parameter on the parameter panel, put the parameter on the center of the circle according to system prompt, as shown in the below illustration.

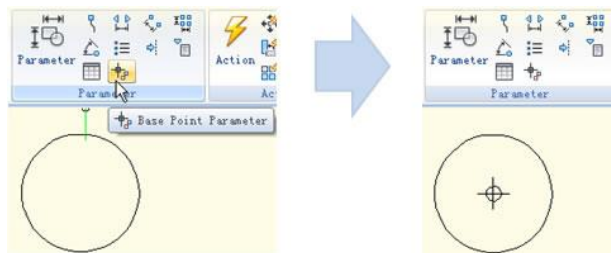

3. **Insert block:** Save and exit block editor, insert the block in the model. You can realize, base point becomes the insert point of the block after adding the base point parameter. Please note, if you set an insert point via the block define dialog box, and add a base point parameter as well, the base point is the default insert point.

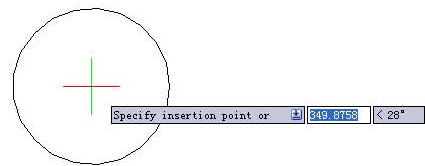

Visibility: Using the Visibility Parameter function, you can control the display and hide a certain view in Dynamic Block.

1. **Prepare view:** Prepare a three cars view and define as block.

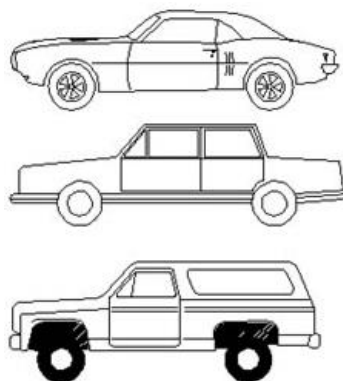

2. Add Parameter of Visibility: Enter into Block Editor by Double-clicking the clock or right- click the menu, click the button Visibility of Parameter in the Parameter panel, appoint the position of the Parameter according to the system prompt, as shown below.

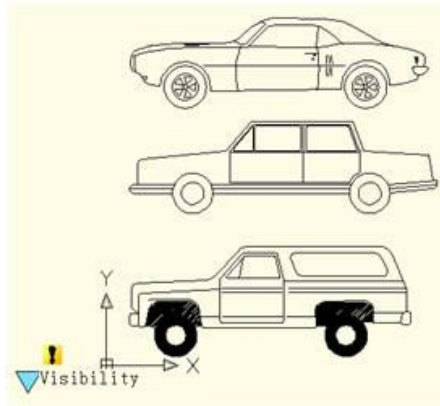

3. Edit the states of Visibility: Double click the button Visibility, the Visibility States dialog box will be displayed. In the dialog box, you can rename, new and remove the Visibility States. In order to control the visibility of the three cars view in this example, we click on new for the three Visibility States as shown in the following picture.

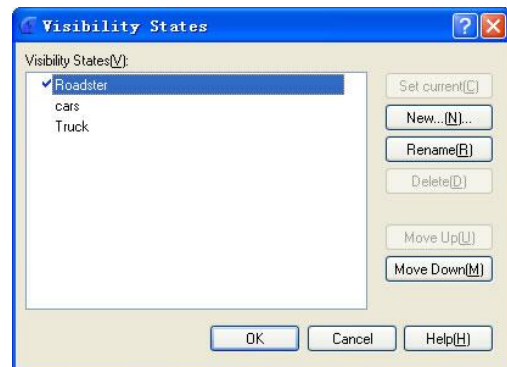

Click the following button as shown in the picture and choose roadster in the pull down menu.

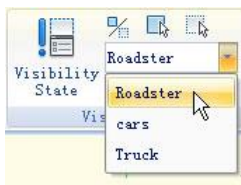

Click the "Invisibility" button in the Visibility tool panel, select truck and car, make them invisible in the "roadster" state, as shown in the following picture, after selecting, press enter to confirm. For the state of "Car" and "Truck", set them in the same way.

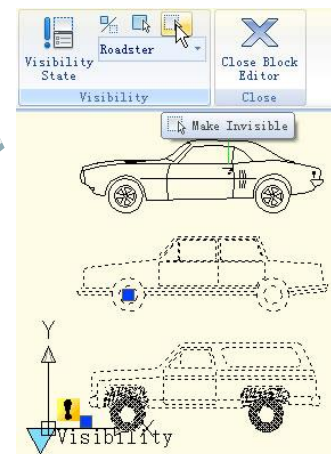

4. Move and Adjust: After finishing the editing of the Visibility States, move the three cars view to make them overlap as shown in the picture below.

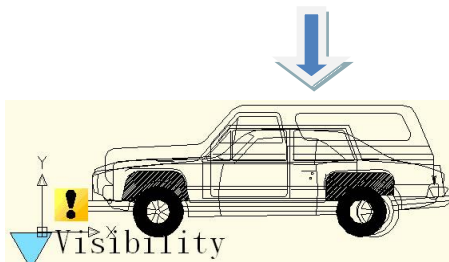

5. Test Dynamic Block: Insert the edited Dynamic Block into a drawing, select Dynamic Block and click the grip of Visibility Parameter, choose one item in the pop-up pull-down list, Dynamic Block will change the display state automatically, as shown in the following picture.

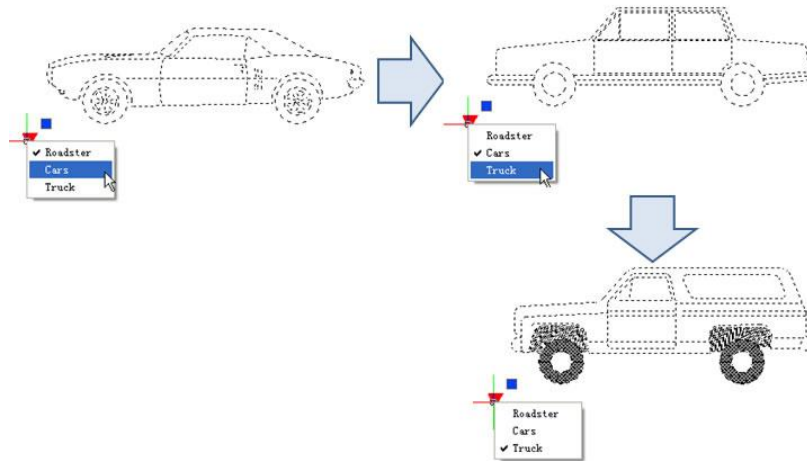

Alignment: Alignment Parameter can give dynamic blocks the function of alignment automatically, which can save the step of rotating the blocks.

1. Add an alignment parameter for a roughness symbol: Draw a roughness symbol in the Block Editor. Select the icon of the alignment parameter. Specify the location and the aligned orientation of the parameter following what the computer asked as shown in the picture, the dotted line is the align orientation.

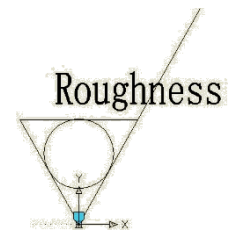

2. Test the dynamic block: Insert the roughness dynamic blocks, move the align grips, the symbol will align with the interface of the dimensions, as shown pin the picture below.

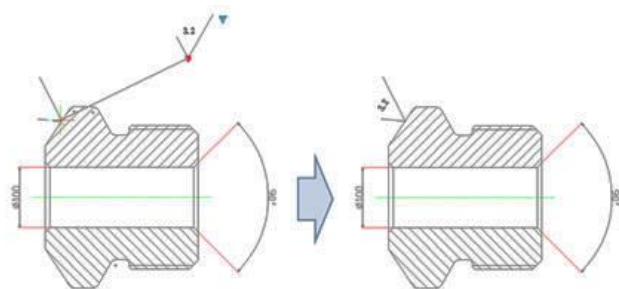

Flip: When you use the "roughness symbol block" to label the spare parts, the symbol is sometimes already in the right position, however, the characters' direction is not right. We need to add the "character flip" function to receive the correct label.

1. Add flip parameter: Click the "flip" parameter button, add the flip parameter according to prompt, as shown in the picture.

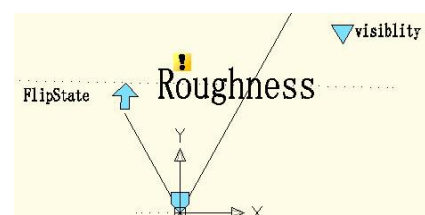

2. Add flip action: Click the flip action button on the action panel, match parameter and object for the action. Herein, we choose "roughness" as the object, and position the action button, as shown in below picture.

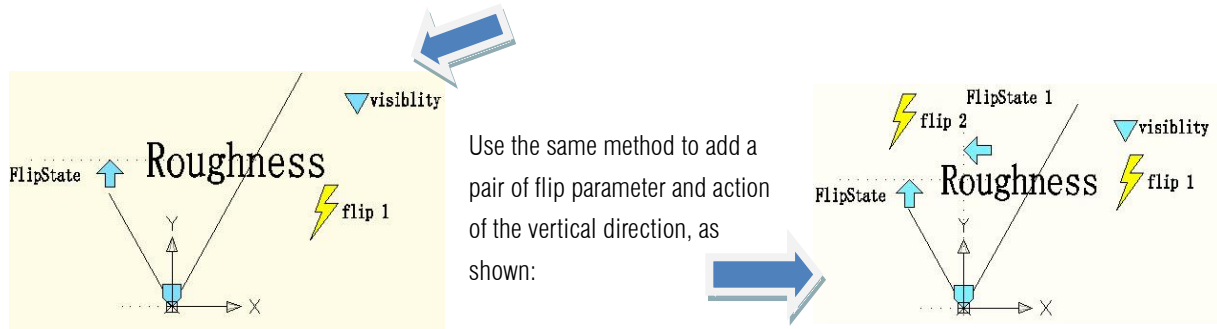

Point Movement:

1. Draw a drawing: Draw a drawing and define it as a block.

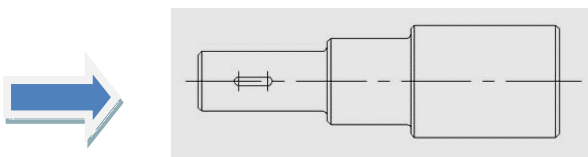

2. Add point parameter: Click point parameter on the tool bar, define the parameter position according to prompt, as shown in the picture.

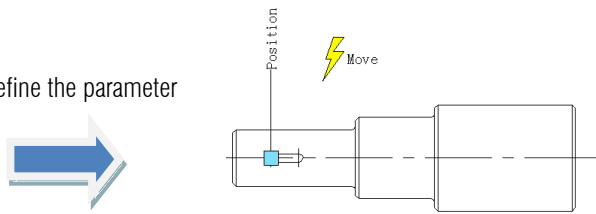

3. Add move action: Click move action button on action panel, match parameter and object for the action, and define the position. The position of action label does not affect the effect of the dynamic block, however, for the sake of beauty& convenience, try to put the label near the related parameter.

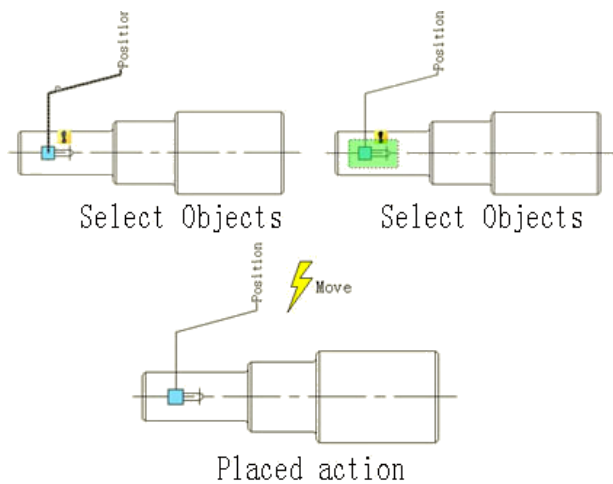

4. Test dynamic block: Insert the dynamic block, drag the blue grip, then move the keyway to the right accordingly, as shown in below picture. Obviously, the dynamic block can achieve the expected results. Please pay attention, if it is not run with ortho constraint, the keyway can move towards every direction because the direction of the point parameter is random, the characteristic of the parameter decides the characteristic of action.

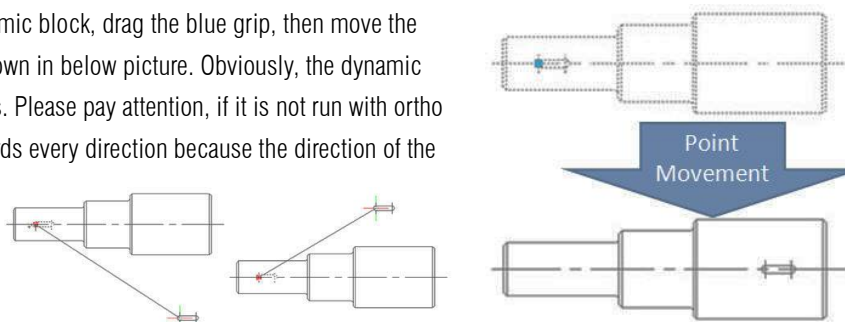

Linear Movement: Actually, limited to the demand of the material mechanics characteristics, keyway is only allowed to be placed on the central line. So, a horizontal movement is enough for keyway and the movement to other direction is not meaningful. Next we will take advantage of the linear parameter to define the keyway's movement direction on the central line of the step shaft.

1. Draw: Draw the follow drawing and define it as a block.

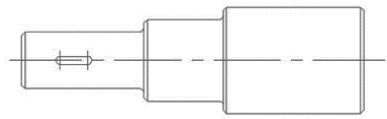
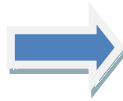

2. Add linear parameter: The way of adding a linear parameter is similar to dimension, both try to put the absorption point of the parameter on the central line of the step shaft.

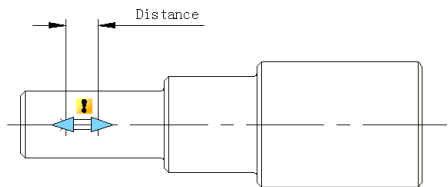

3. Add Move Action: Different from the point move, after specifying the parameter, the system will prompt: Specify parameter that is related to movement. Select right grip of parameter as "Related parameter point", as shown in the following picture.

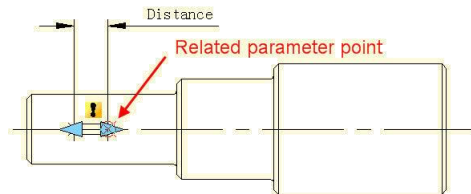

The parameter point we mentioned corresponds to the operate point of Move. After exiting Block Editor you can drag this point to make dynamic block change correspondingly. After selecting the related parameter point you can specify the move objects for action, as shown in the following picture. Place action label, save and exit dynamic block.

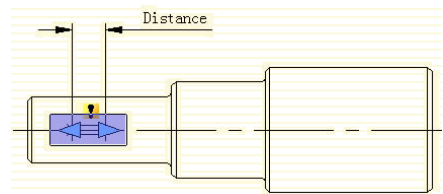

4. Testing Dynamic Block: Select dynamic block and drag the right grip of the parameter. Meanwhile, no matter how the cursor moves, the keyway is limited to the central line of the step shaft. That is to say with the limitation of the linear parameter, the dynamic block can only move along the direction specified by the linear parameter.

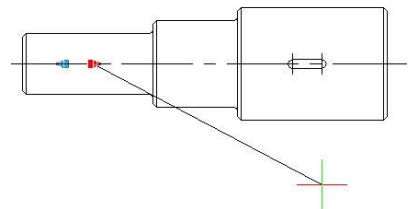

Number of Grips: In the Block Editor, select the linear parameters, change the number of grips to "1" in the properties panel.



Distance	0.8001
Angle	0
Value set	
Dist type	None
Dist minimum	0
Dist maximum	
Base Location	Start Point
Show Properties	Yes
Chain Actions	No
Number of Grips	2
Number of Grips	1
Number of Grips	2
Number of Grips	1
Number of Grips	2

Save and exit the Block Editor, choose the Dynamic Block, you will find that one grip has disappeared. In fact, after changing the number of grips from "2" to "1", the first thing that disappeared was the basic grip of parameters, namely the first point when adding parameters.

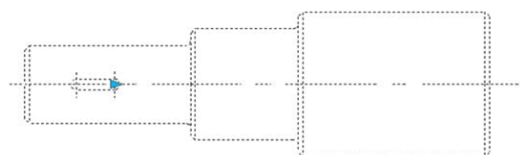

Angle Offset: Open Block Editor, choose the Angle offset from 0° to 30° in the action property, save and exit the block editor

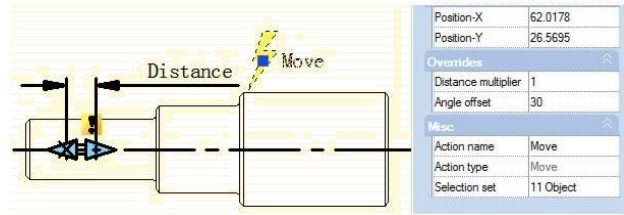

Select the Dynamic Block and then move the right side grip. You will find it can only move in the direction of 30° as it is shown in the following picture. The direction of action can change according to the Angle Offset.

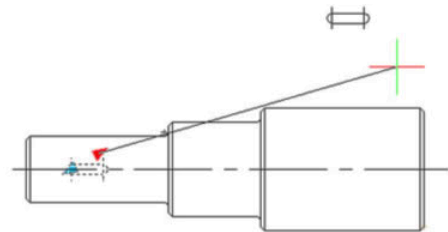

Linear Stretch: During a mechanical design, we often need to change the position as well as the dimension of the keyway. In this section, we will add Linear Tensile function for the keyway on the step shaft.

1. Add linear parameter:

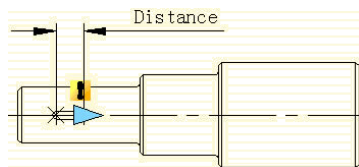

2. Add stretch action: Click the stretch action button on the action panel, choose parameter according to prompt and define right grip as key parameter point, as shown in below picture. The black object is the operational object of the action, the broken line frame is the stretch frame, objects intersect with stretch frame will be stretched, objects which will be selected by the stretch frame will move.

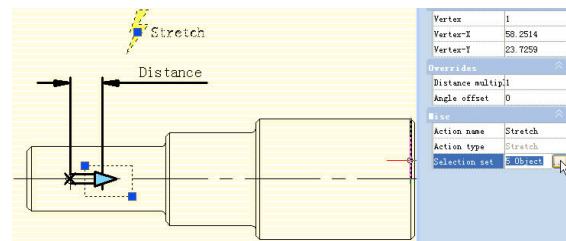

3. Test dynamic block: Exit from block editor, drag stretch grip to stretch the keyway, as shown in the picture.

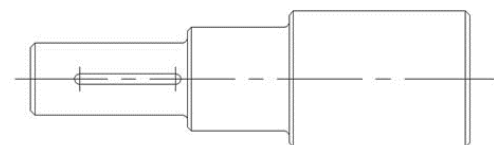

Parameter Value Set: For mechanical designs, we often need to stretch the keyway to a certain length. Now, let us see how to realize an accurate stretch. Pick linear parameter in block editor, click entry frame which is on the right side of "distance type" on the Properties panel, a drop-down menu will pop up.

Therein, none is the default option, which means it can stretch optionally. With the other two options, you can define the maximum and minimum number respectively.

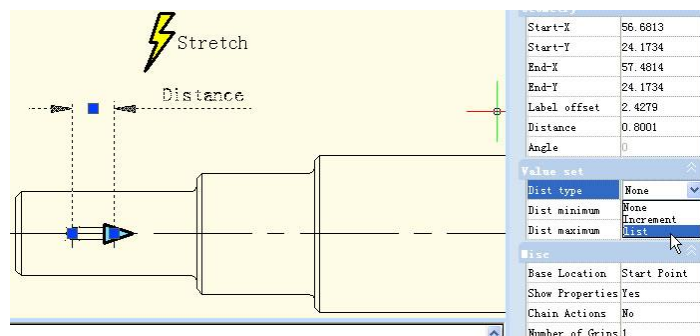

"Increment" means stretch increasingly, a Value set appears as shown below after selecting increment. If you choose "list", a Value set appears as shown in below picture, the dynamic block can only be stretched according to the number in the list.

Value set	
Dist type	Increment
Dist increment	0
Dist minimum	0
Dist maximum	

Value set	
Dist type	list
Dist value list	0.8001

Click the text frame which is on the right side of the "distance value list", one button with ellipsis on it will appear. Click this button, a "Add distance" dialog box will be displayed. Add three numbers "1" "1.5" "2" in the dialog box, as shown in below picture.

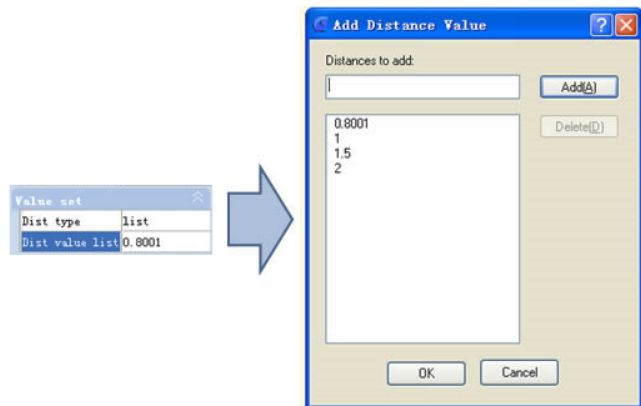

Exit from block editor and stretch the right grip, you will see several gray lines appearing on the right side of the keyway, and the keyway can only be stretched to the gray line position, as shown in below picture. Obviously, by value list, you can define certain numbers of the stretch, to realize an accurate stretch.

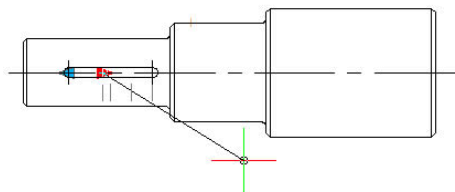

Symmetrical Stretch: There is an easy way to realize the two-way stretch which is adding two actions of stretch. Though it can realize a two-way stretch, the action of stretch is independent. The parameter needs some additional setup to realize the two-way symmetrical stretch.

- First, add two stretch actions for parameter, and select the two grips of the two parameters as the relevant point of each action.
- Second, in the misc, modify the base location from "Start Point" to "Mid Point", like shown in the picture below. Save and exit the block editor.

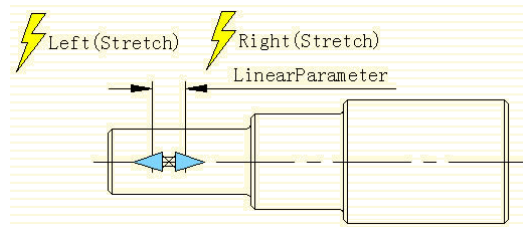

For the convenience of watching the effect, we drew a vertical center line in the middle of the keyway, and then stretched the grip to the left side of the keyway or the right side, as shown in the picture below. As the grips are moving, the two-way symmetrical stretch is realized.

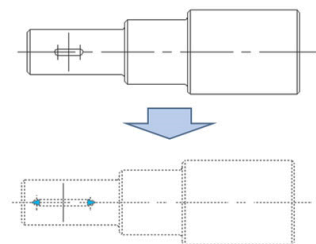

Distance Multiplier: Take the step shaft as an example, if we stretch the left part of the step shaft and the keyway still is at the center point of the smaller diameter shaft after stretching. Then, we use the "Distance Multiplier" property of action to achieve the aim.

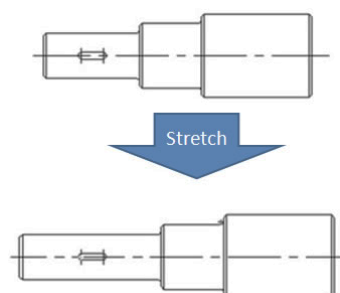

1. Add linear parameter and stretch action for step shaft:

Hide the right grip of the parameter point, the action stretch box is as in the following picture, the bolded object is the action operation object.

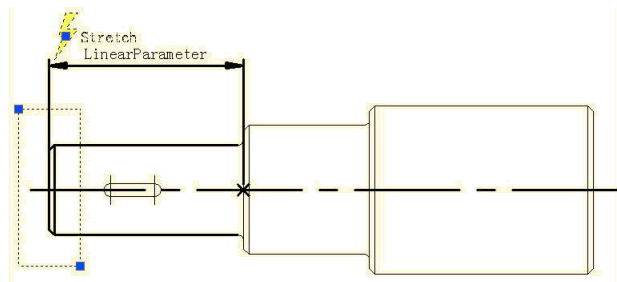

2. Add Move Action for keyway:

Select the left grip of the linear parameter when moving, stretching the related parameter points. Move the objects of action and select the whole keyway, as in the following picture.

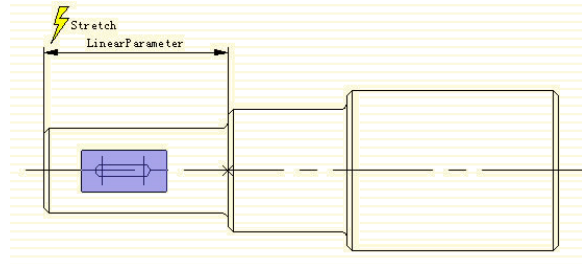

3. Modify distance multiplier of action: Select Move Action and modify the default value from 1 to 0.5 in the property of the distance multiplier, save and exit the block editor.

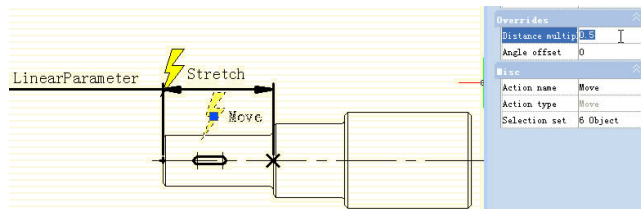

4. Test Dynamic Block: Stretch leftwards grip and with the grip moving leftwards, the smaller diameter shaft will appear with a stretch effect, the keyway will also move leftwards accordingly, meanwhile, the keyway is in the center of the smaller diameter shaft of the step shaft all the time. Although Stretch and Move have a common parameter, when the Distance Multiplier of Move is modified to 0.5, the displacement of Move can only stretch 0.5 times of the displacement.

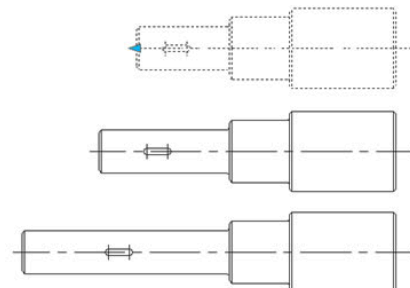

Chain Action: If you want to realize a symmetric stretch without changing the keyway center and the length of smaller diameter shaft changes with the stretch at the same time, how can you realize that?

1. Add stretch for Step Shaft: Add stretch parameter and action for step shaft as the following picture shows. There into, the bolded objects indicate the operation object of action. Because the follow-up operation will not stretch the step shaft by grips of this linear parameter, the grip's number of the linear parameter can be modified to "0".

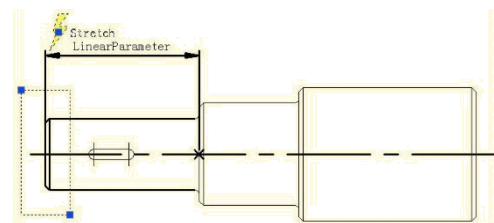

2. Add linear parameter for keyways: Set the base point position of the line parameter as "Center" in order to realize the symmetric stretch function.

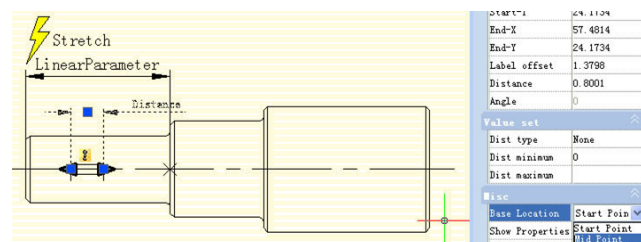

3. Add the stretch rightwards action for the keyway and realize chain action: Select the “Distance” linear parameter and modify the chain action of prosperity from “NO” to “Yes” as the following picture shows:

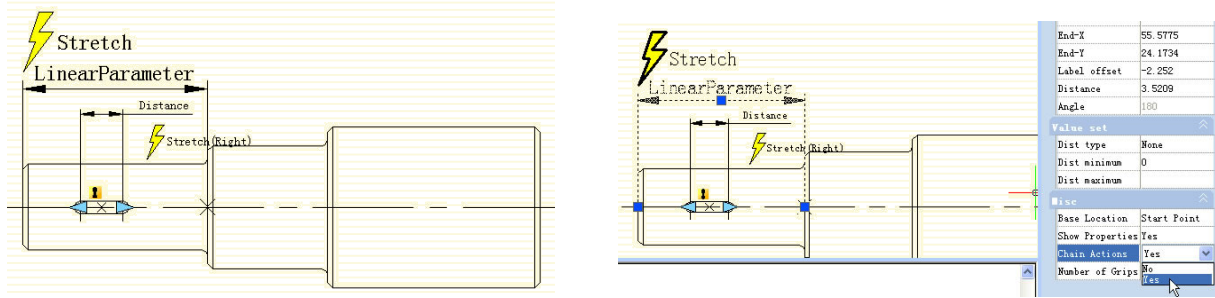

Add the Stretch Leftwards action for keyway as the following picture shows.

Special Note: Do elect “Distance” for the linear parameter to stretch leftwards the operation objects set. This is a necessary procedure of the chain operation.

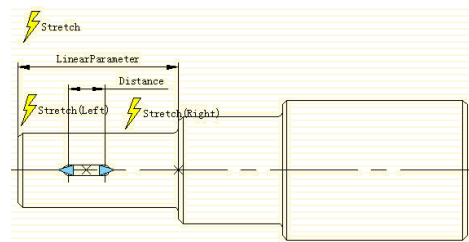

4. Test Dynamic Block: After dragging the left grip, not only the keyway will stretch bi-directionally and symmetrically but also the smaller diameter shaft of the step shaft will stretch automatically. This is a chain action. The realization of a chain action has two important procedures: First, modify the property value of the parameter that need to happen as linkage and modify the property of “chain action” from “NO” to “YES”. Second, elect the parameter of objects that are elected to linkage action to set.

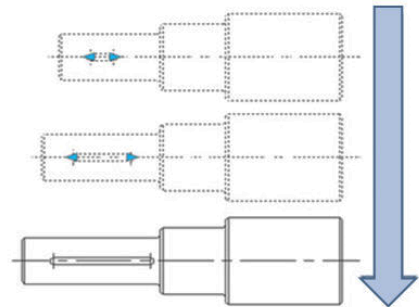

Scale Action: Scale Action can be matched with the Linear Parameter, Polar and XY Parameter to achieve various Dynamic effects.

Linear Scale

1. Draw: Finish drawing an access hole in a model space and define it as a block, as shown in the following picture.

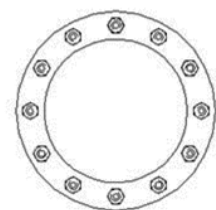

2. Add Linear Parameter: Enter into Block Editor to add a linear parameter. The start point of the Linear Parameter is the center of the circle, and choose the number of grip as “1” as shown in the following picture.

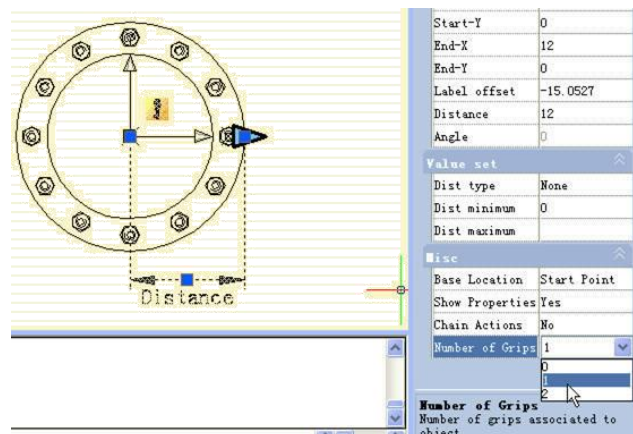

3. Add Action: Click the Scale icon on the Action Panel, appoint parameter for Action and box the whole access hole as Action Object, as shown in the following picture.

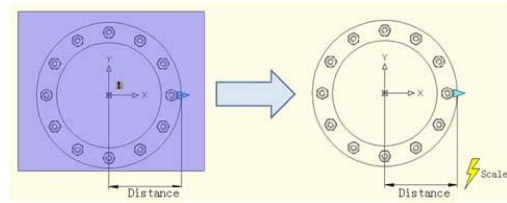

4. Test Dynamic Block: Exit from Block Editor and insert the Dynamic block, after pitching up the Dynamic Block, drag the triangle grip, the objects (nuts) will scale with it.

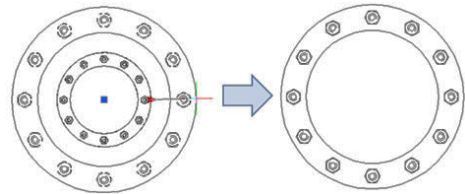

Polar Scale

When we move the Scale Grip of the Access Hole on the left of circle center, namely move the base point of the Linear Parameter to the left of the circle center, we will find that the block does not have a corresponding Scale, as shown in the following picture.

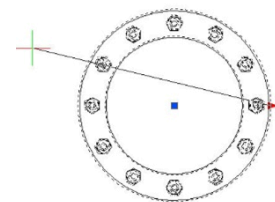

The reason for this is that the Endpoint of the Linear Parameter cannot cross its base point, so we change the Linear Parameter to be a Polar Parameter, we do not change any other operations, as shown in the following picture.

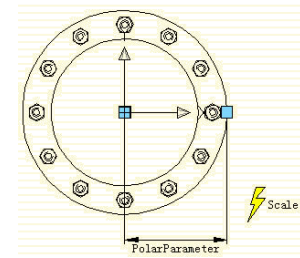

Exit from Block Editor, Drag the grips of the Access hole Block again, you can see, that after the change from Linear Parameter to Polar Parameter, we can drag the grip to scale the dynamic block in any direction.

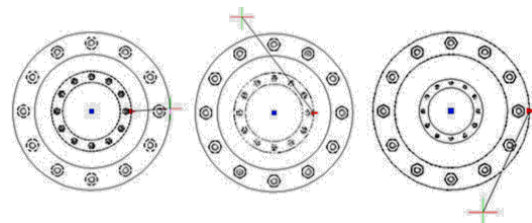

Scale Character: In this section, we will explain some Scale characters using XY Parameter and Scale Action in a paired example.

1. Drawing graphics: Draw the graphics which need a dynamic block and define them as a block as below:



2. Add XY Parameter: Entry Block Editor, add XY Parameter. Parameter adding is similar to Linear Parameter. Pick the first point of the parameter from the left bottom corner of the rectangle as the base point, the second point from the top right corner and change the Number of Grips to “1”. Then add Scale Action, as shown below.

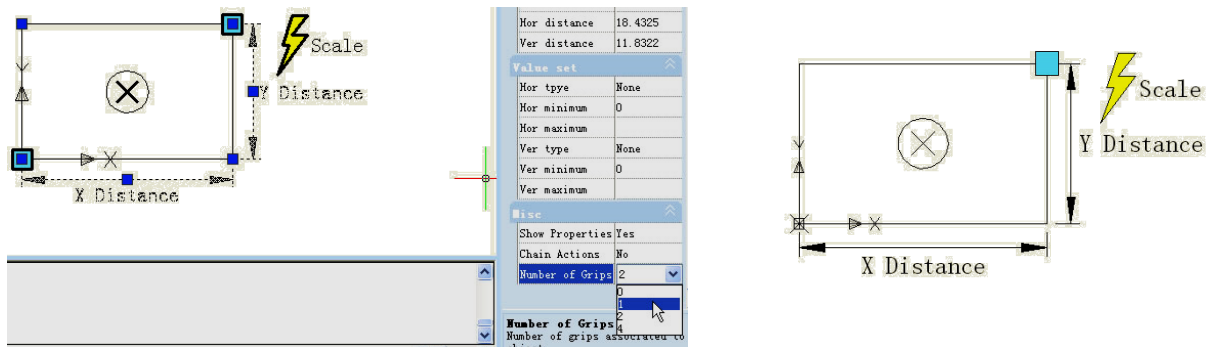

3. Test the Dynamic Block: After exiting the Block Editor, drag the grip of the top right corner of the rectangle, you can see the whole dynamic block is scaling as the grip is moving. It is easy to find that both the circle and the rectangle scale by the base point of the XY Parameter.

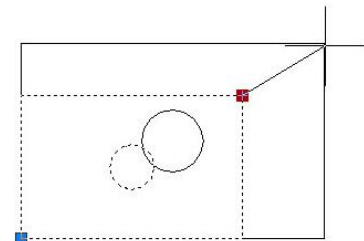

5. Modify Action Base: Modify Base type: go back to Editor, select Scale Action and change the default “Dependent” to “Independent”.

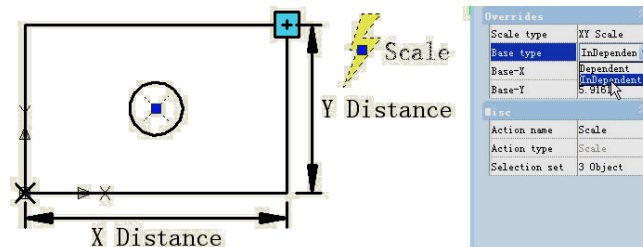

Specify new base: Single click the right input box of “Base-X” and “Base-Y”, you can manually input the coordinate value or you can single click the small button with ellipsis dots on the right of the input box and snap the base point, as shown:

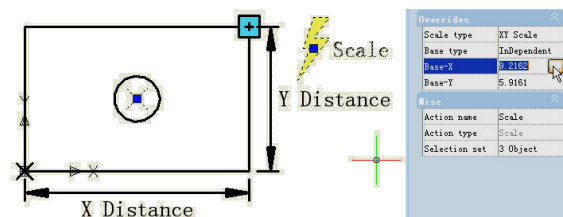

Specify the base point by crosshair and the circle center as base point. After exiting Block Editor, scale the dynamic block. After modifying Base type and position, the scale center of the dynamic block changes from the XY Parameter base point to the new specified base point (center of the circle).

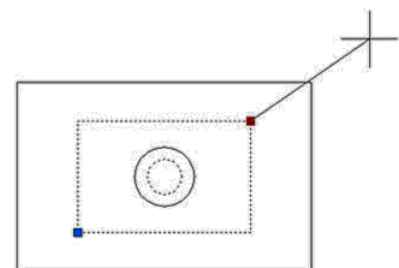

6. Scale Type: There is “Scale Type” in the Scale Action Properties. The default value is “XY Scale”. If you choose “XY Scale”, the dynamic block scales whenever the scale grip moves to X axis or Y axis. If you choose “X Scale”, it scales only when the grip of the scale moves to X axis. Same, when you choose “Y Scale”.

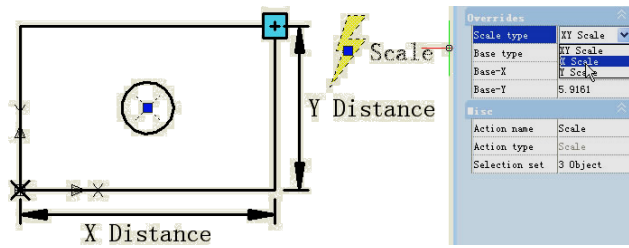

Rotation: In this section, we are going to use a rotation parameter and rotate action to add a dynamic rotate function to view index symbols (English system) which are frequently used in architectural drawings.

1. Draw a drawing: Draw a view index symbol and define as a block, as shown in below picture. Please define view number and drawing number as attribute text, so as to revise whenever you want.

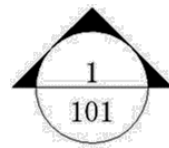

2. Add rotation parameter: Pick the center of the circle as the first point of the parameter, system default it as the rotation point, set angle type as "increment", and define its number as 15 degree, as shown below.

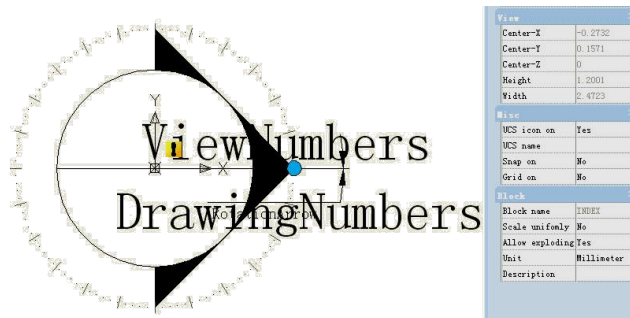

3. Add rotate action: Click the rotation action button on the action panel, match parameter, object and position for the action and select the whole index symbol as the object of the action.

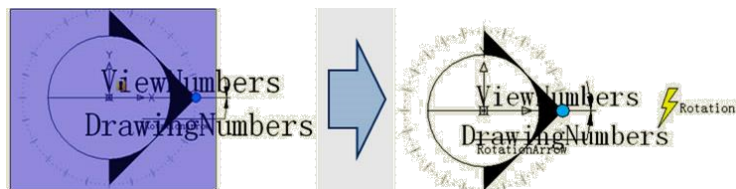

4. Test dynamic block: Exit from block editor and insert the block, drag rotation grip to reach the effect of rotation, as shown in below picture.

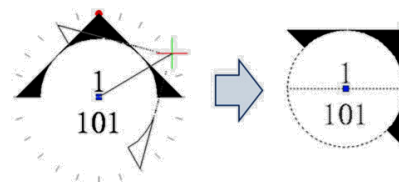

Polar Stretch: We use the Polar Stretch function of Dynamic Blocks to draw the section symbol in this section.

1. Draw, Mirror and Define as a Block: The follow drawing includes the attribute text which can be modified as you need. Then mirror this drawing and define the mirrored object as a block.



2. Add action and parameter for the attribute text: Add Point Parameter and Move Action for text and change the Chain Action to "Yes". It is ready for next step to create Chain Action for Polar Stretch Action.

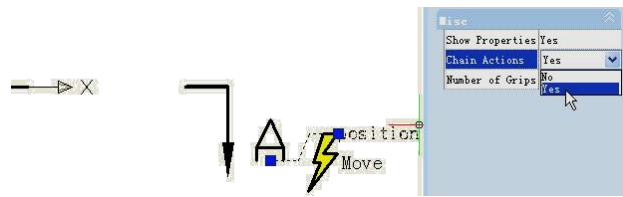

3. Add Polar Parameter and Action: Add Polar Parameter whose first point should be the center of the section symbol. This point will be the rotation center of the Polar Parameter. Follow the instructions below:

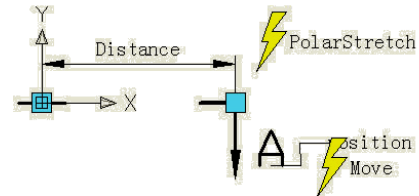

1. Pick the right grip of the Polar Parameter as an associated parameter point and specify the Stretch box (Fig. 3.1).
2. Select objects to stretch and the "position" Point Parameter together, which can accomplish that the text and section symbol are moving together (Fig. 3.2).
3. Specify objects which rotate only for Polar Stretch Action (Fig 3.3).
4. Specify Action symbol location (Fig 3.4)
5. Repeat the above steps to add the same parameter and action order for the left part.

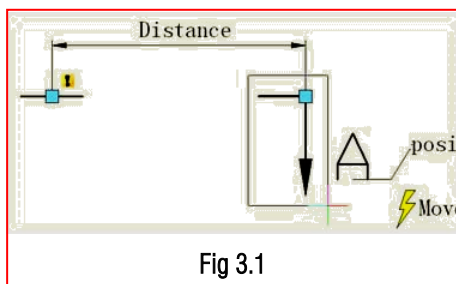

Fig 3.1

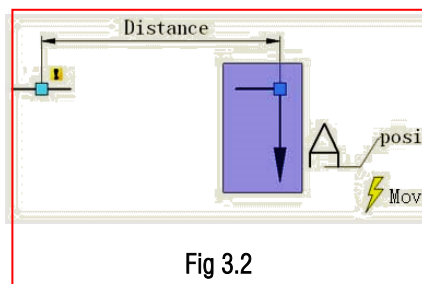

Fig 3.2

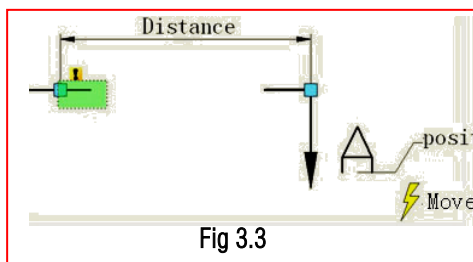

Fig 3.3

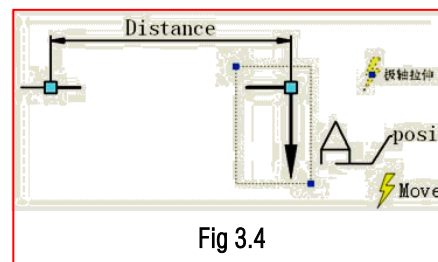
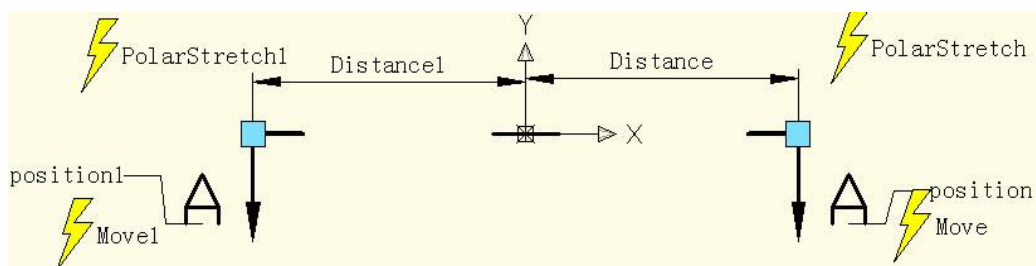

Fig 3.4

It is better if you hide the grips which are not associated with the Polar Stretch Parameter as below:



4. Test Dynamic Block:

Open the graphic which needs to be dimensioned and insert the completed dynamic block (Fig 4.1). Drag the grip of the dynamic block, the section symbol can be stretched outward and rotated around the center, and you finish the section symbol mark (Fig 4.2).

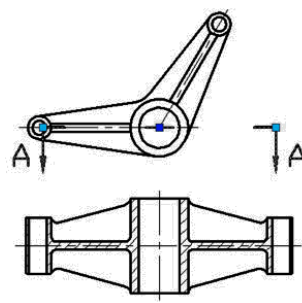

Fig 4.1

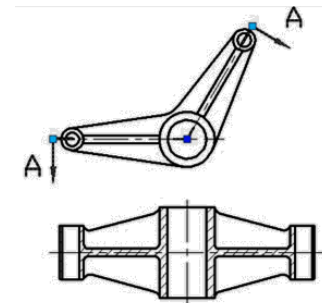
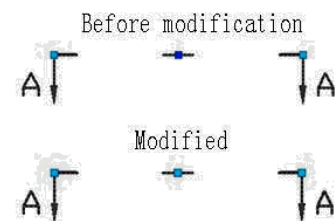

Fig 4.2

Polar Stretch Action Characteristics: Modify the grips' number of the polar parameter in the section symbol dynamic block in the last example to display both of the two grips of the polar parameter. From the following picture we can see that the central grip is clearly different before and after. Before modifying, the central point was actually the base point of the block, and this was the insert point. But after modifying, the center point of block is the base point of the polar parameter.



Clicking central grip can move the grip to any direction. Meanwhile, the dark blue insert point of block will appear again, as shown in the following picture. Obviously, the insert point is only covered by the base point of the polar parameter. The base point of the polar parameter can move arbitrarily, but for the block it seems that no change is happening. But is it true?



In order to confirm if the block changes or not, we move the grips on both terminals and we can find that the section symbol does not center on the dark blue base point when changing but it takes the base point of the polar parameter as a rotate center, as shown in the following picture.

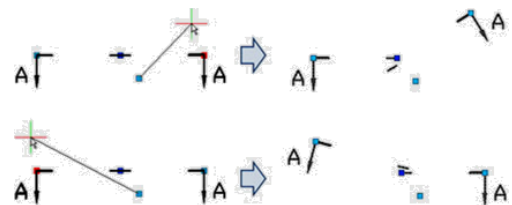

Enter block editor, move up the parameter and the other settings do not change.

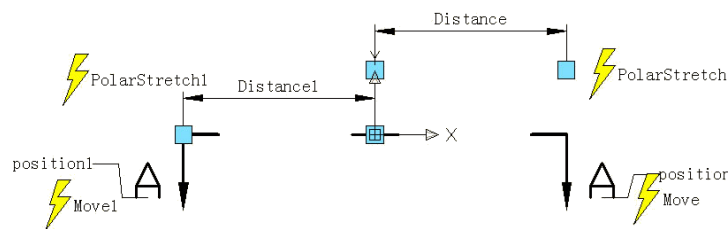

Exit block editor, move the right grip and you can see that rotate center moves up along with the parameter. From the examples above it is difficult to understand that the polar parameter cannot move arbitrarily like the point parameter and linear parameter, the reason is that the base point of the polar parameter specifies the rotate center of the object, once the parameter is moved, the rotate center will move accordingly. That the rotate parameter cannot move arbitrarily has the same reason.

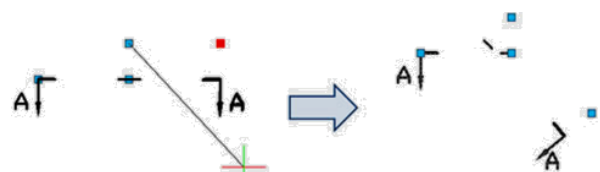

Array: For the Array function of Dynamic Block we need to use Array Action, we use Array Action to match with Linear Parameter, Polar Parameter, XY Parameter to achieve various Arrays.

Linear Array

No.	Name	Number	Materials	Norm	Note

1. **Draw:** Draw a parts list and define it as a block.

2. **Add Linear Parameter:** After adding Array Action, we can drag the two grips of the Parameter to make a list array, but obviously, we hope just to achieve an up array of the blank bar, not a down array, so to avoid a mistakes, we should hide the grip under the Parameter, as in the following picture.

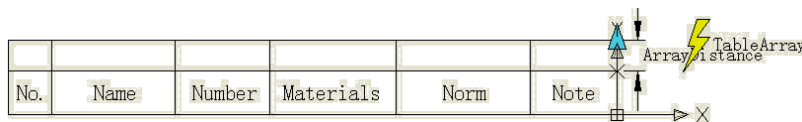

3. **Add Array Action:** During the add Array Action, the system will require to appoint space between columns. The space between columns is the distance between the objects that the array created. Here, the line width is 7mm, for the line between the lines a close up array can be chosen, we appoint that the space between the columns is 7mm.

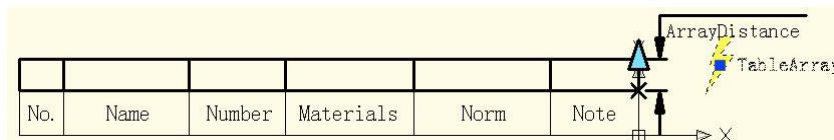

4. **Test Dynamic Block:** Insert Dynamic Block, drag the top right corner grip upwards, the line number of the part list will be added automatically, as in the following picture.

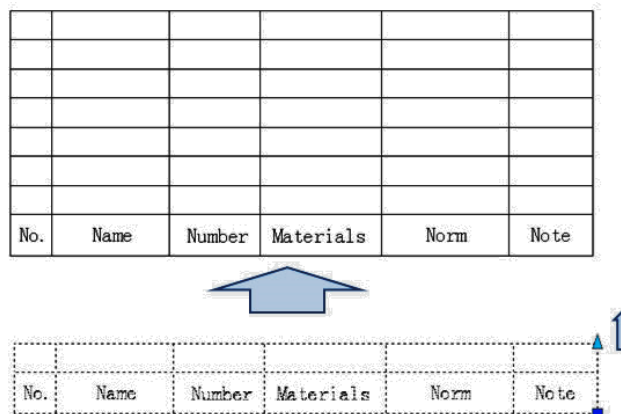

XY Array

Compared with Linear Array, XY Array has a vertical direction Array.

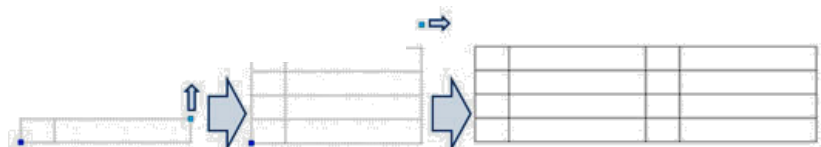

Polar Array

We see a Dynamic Block example as follows, after dragging grip, the effect will be as in the following picture. You can see, not only can we stretch the fence, but we can also rotate the direction casually, this is the effect combining Polar Stretch with Polar Array.

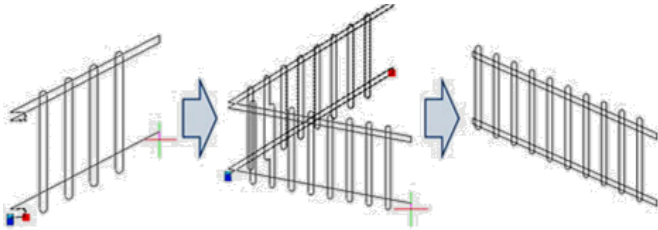

Enter into Block Editor, Stretch, the ways of adding Array Action as in the following picture, the bold object expresses the relevance with the selected action. The Polar Parameter determines the way of Array directly, the Polar Array will regard the direction of the Polar Parameter as Array direction, achieving Array functions in any direction.

